

RESOLUTE™ absolute optical encoder with BiSS serial communications



RESOLUTE is a revolutionary new true absolute, fine pitch optical encoder system, with excellent dirt immunity, offering an impressive specification that breaks new ground in position feedback.

RESOLUTE's patented technology combines 1 nm resolution with exceptionally high speed, up to 100 m/s (36 000 rev/min), reading from a range of high accuracy linear tape and spar scales or angle encoder rings.

RESOLUTE uses a unique single optical absolute track (a world first) with a nominal pitch of 30 μm , combined with sophisticated optics. This ensures wide set-up tolerances, very low sub-divisional error of ± 40 nm and ultra-low noise (jitter) of less than 10 nm RMS, resulting in better velocity control performance and rock solid positional stability.

Reliability is assured by **RESOLUTE**'s excellent dirt immunity, built-in separate position-checking algorithm and IP64 sealed readhead with wipe-clean recovery.

RESOLUTE is available with a variety of serial protocols. Please contact your local representative for the latest list.

- True absolute non-contact optical encoder system: no batteries required
- Wide set-up tolerances for quick and easy installation
- High immunity to dirt, scratches and light oils
- Resolutions to 1 nm or 32 bit rotary
- 100 m/s maximum speed for all resolutions (to 36 000 rev/min)
- 30 μm nominal scale pitch ensures exceptional motion control performance
- ± 40 nm sub-divisional error for smooth velocity control
- Less than 10 nm RMS jitter for improved positional stability
- Built-in separate position-checking algorithm provides inherent safety
- IP64 sealed readhead for high reliability in harsh environments
- Integral set-up LED enables easy installation and provides diagnostics at a glance
- Readhead and linear/rotary scales are bolt-hole compatible with **SIGNUM**™ encoders
- Operates up to 80 °C
- Integral over-temperature alarm
- Variety of serial protocols available. Contact your local representative for the latest list

Compatible with:

- **RELA Invar**® spar scales
- **RSLA stainless steel spars**
- **FASTRACK**™ with **RTL A**
- **RTL A-S self adhesive tape scale**
- **RESA angle encoders**
- **Ultra-high accuracy REXA angle encoders**

System features



Unique single track absolute optical scale

- ▶ Absolute position is determined immediately upon switch-on
- ▶ No battery back-up
- ▶ No yaw de-phasing unlike dual-track systems
- ▶ Fine pitch (30 µm nominal period) optical scale for superior motion control compared to inductive, magnetic or other non-contact optical absolute encoders
- ▶ High accuracy graduations marked directly onto tough engineering materials for outstanding metrology and reliability

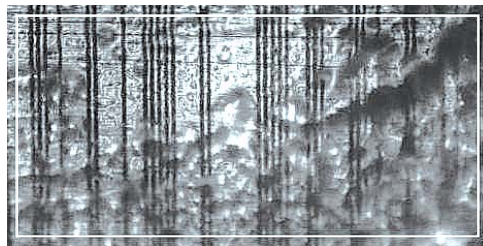

High dirt immunity

- ▶ Advanced optics and embedded surplus code means RESOLUTE even reads dirty scale
- ▶ Absolute position can be determined in all three cases shown here; clean scale (left), grease contamination (below-left), particle contamination (below)

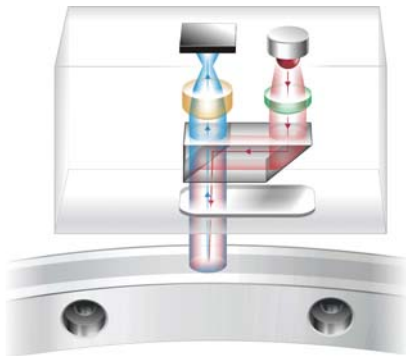

Unique detection method

- ▶ Readhead acts like an ultra fast miniature digital camera, taking photos of a coded scale
- ▶ Photos are analysed by a high-speed DSP to determine absolute position
- ▶ Built-in position-check algorithm constantly monitors calculations for ultimate safety and reliability
- ▶ Advanced optics and position determination algorithms are designed to provide low noise (jitter < 10 nm RMS) and low sub-divisional error (SDE ±40 nm)

Range of rotary (angle) and linear scales

- ▶ Tough RELA high-precision INVAR spars with ±1 µm accuracy available up to 1130 mm length
- ▶ Shatter-proof RSLA high-precision stainless steel scale, offering higher accuracy than glass scales and long lengths up to 5 metres, with ±4 µm accuracy over a complete 5 metre length (for longer lengths contact your local representative)
- ▶ RTLA with *FASTRACK*, and RTLA-S tape scales with ±5 µm/m accuracy and easy installation
- ▶ RESA ring with unique taper mount has large through hole for easy installation
- ▶ REXA ultra-high accuracy ring with ±1 arc second total installed accuracy with dual readheads

Range of protocols and resolutions

Protocol	Resolutions	
	Linear	Rotary
<i>BiSS</i>	50 nm	18 bit
	5 nm	26 bit
	1 nm	32 bit

Other serial protocols are available. Please contact your local Renishaw representative for information.

Linear absolute encoder version

Resolutions and scale lengths

The maximum scale length is determined by the readhead resolution and the number of position bits in the serial word. For RESOLUTE readheads with fine resolution and short word length, the maximum scale length will be limited accordingly. Conversely, coarser resolutions or longer word lengths enable the use of longer scale lengths.

RESOLUTE is available with a variety of serial protocols, but the example here shows RESOLUTE using *BiSS-C* (uni-directional) protocol with three options for the position word length; 36 bit, 32 bit and 26 bit.

The 36 bit and 32 bit position word facilitates longer lengths that can be a significant benefit, especially at fine resolutions.

Resolution	1 (nm)	5 (nm)	50 (nm)
Maximum scale length (L) with 36 bit position word	10 m	10 m	10 m
Maximum scale length (L) with 32 bit position word	4.295 m	10 m	10 m
Maximum scale length (L) with 26 bit position word	67 mm	336 mm	3.355 m
Maximum reading speed	100 m/s	100 m/s	100 m/s

For 5 nm and 50 nm resolution readheads with a 32 bit position word, it is possible to use the full 10 m scale length offered by RTLA and RSLA.

For all resolution readheads with a 36 bit position word, it is possible to use the full 10 m scale length offered by RTLA and RSLA.

Please contact your local Renishaw representative for lengths above 5 m.

Please contact your local Renishaw representative for details of other serial protocols.

Scale specifications

For more detailed scale information please refer to relevant scale data sheet

Description	RELA	High-performance Invar spar scale for very high accuracy applications requiring very low thermal expansion. Lengths up to 1130 mm.	
	RSLA	High-performance stainless steel scale for very high accuracy applications with longer axis lengths. Lengths up to 5 m. (For longer lengths contact your local Renishaw representative)	
	<i>FASTRACK</i> /RTLA	Track-mounted hardened stainless steel tape scale for high performance motion control systems requiring easier and faster scale installation and field replacement. RTLA lengths up to 10 m, <i>FASTRACK</i> lengths up to 25 m.	
	RTLA-S	Self-adhesive hardened stainless steel tape scale for high performance motion control systems requiring easiest installation. Lengths up to 10 m [†] .	
Accuracy	RELA	±1 µm	up to 1130 mm
	RSLA	±1.5 µm	up to 1 m @ 20 °C
		±2.25 µm	up to 2 m @ 20 °C
		±3 µm	up to 3 m @ 20 °C
		±4 µm	up to 5 m @ 20 °C
<i>FASTRACK</i> /RTLA	±5 µm/m	@ 20 °C	
RTLA-S	±5 µm/m	@ 20 °C	
Thermal expansion coefficient	RELA	~ 0.6 µm/m/°C (0 °C to 30 °C)	
		< 1.4 µm/m/°C (30 °C to 100 °C)	
	RSLA	~10.8 µm/m/°C	
	<i>FASTRACK</i> /RTLA	~10.6 µm/m/°C	
	RTLA-S	~10.6 µm/m/°C	

[†]For lengths >2 m, *FASTRACK* with RTLA is recommended.

Angle absolute encoder version

Resolution

RESOLUTE is available with a variety of resolutions, to meet the needs of a wide range of applications. The choice of resolutions depends on the serial protocol being used, but there are no limitations due to ring size, eg *BiSS* 26 bit resolution is available on all ring sizes.

BiSS RESOLUTE resolution options:

- 18 bit (262 144 counts per revolution, \approx 4.94 arc second)
- 26 bit (67 108 864 counts per revolution, \approx 0.019 arc second)
- 32 bit (4 294 967 296 counts per revolution, \approx 0.00030 arc second)

Note that 32 bit resolution is below the noise floor of the RESOLUTE encoder.

For resolution options on other protocols, please contact Renishaw.

Speed and accuracy

RESA diameter (mm)	Maximum reading speed (rev/min)	System accuracy (arc second)
52	36 000	\pm 5.49
75	25 000	\pm 3.82
104	18 000	\pm 2.69
115	16 500	\pm 2.44
150	12 000	\pm 1.91
209	9 000	\pm 1.4
229	8 300	\pm 1.27
255	7 400	\pm 1.11
300	6 300	\pm 0.95
350	5 400	\pm 0.82
417	4 500	\pm 0.68
489	3 900	\pm 0.59
550	3 400	\pm 0.52

System accuracy is graduation accuracy plus SDE. Effects such as eccentricity influence installed accuracy; for application advice, please contact your local representative.

Caution: Very high speed motion axes require additional design consideration. For applications that will exceed 50% of the rated maximum reading speed of the ring, please contact Renishaw for further advice.

Operating and electrical specifications (angle and linear)

Power supply	5 V \pm 10%	1.25 W maximum (250 mA @ 5 V)
	Ripple	200 mVpp maximum @ frequency up to 500 kHz maximum
Temperature	Storage	-20 °C to +80 °C
	Operating	0 °C to +80 °C
Humidity		Rated up to +40 °C, 95% relative humidity (non-condensing)
Sealing		IP64
Acceleration (Readhead)	Operating	500 m/s ² BS EN 60068-2-7:1993 (IEC 68-2-7:1983)
Shock (Readhead)	Non-operating	1000 m/s ² , 6 ms, ½ sine BS EN 60068-2-27:1993 (IEC 68-2-27:1987)
Maximum acceleration of scale with respect to readhead		BiSS - 2000 m/s ² NOTE: This is the worst case figure that is correct for the slowest communications request rates. For faster request rates, the maximum acceleration of scale with respect to the readhead can be higher. For more details, please contact your local representative.
Vibration	Operating	300 m/s ² max @ 55 Hz to 2000 Hz BS EN 60068-2-6:1996 (IEC 68-2-6:1995)
Mass		Readhead 18 g Cable 32 g/m
EMC compliance		BS EN 61326-1: 2006
Cable		Double-shielded, outside diameter 4.7 \pm 0.2 mm Flex life >20 x 10 ⁶ cycles at 20 mm bend radius UL recognised component 

NOTE: **Class 1 LED product**

RESOLUTE angle nomenclature

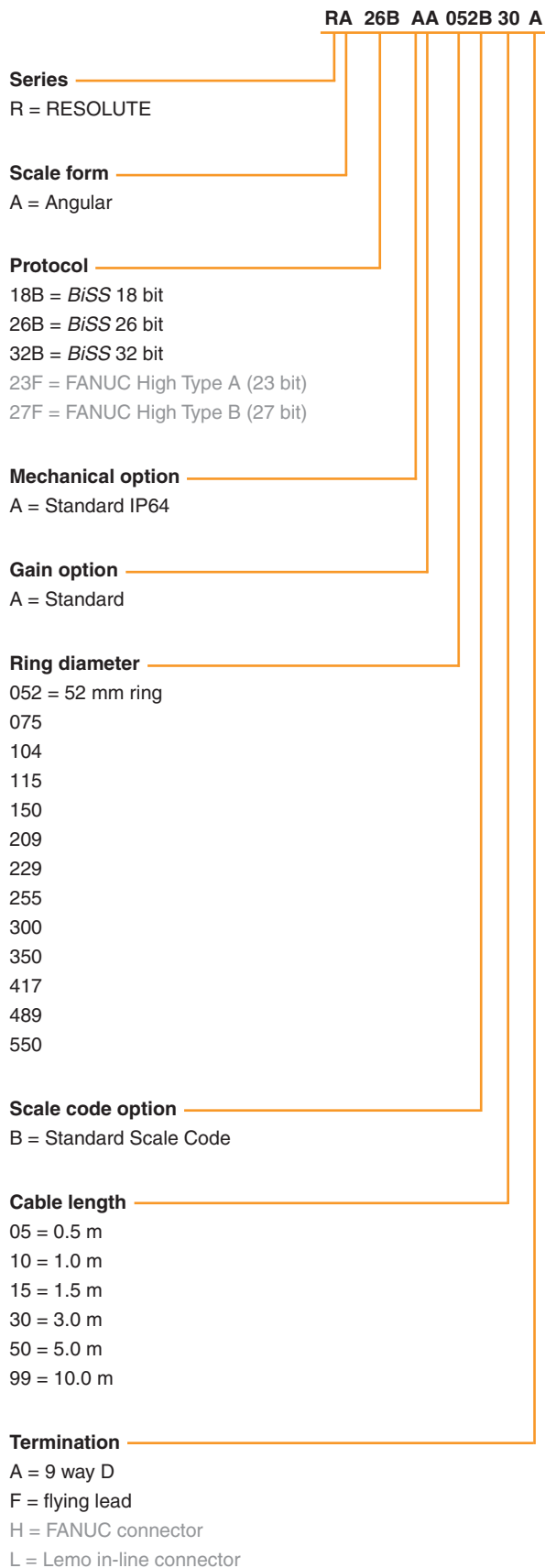

RESOLUTE linear nomenclature

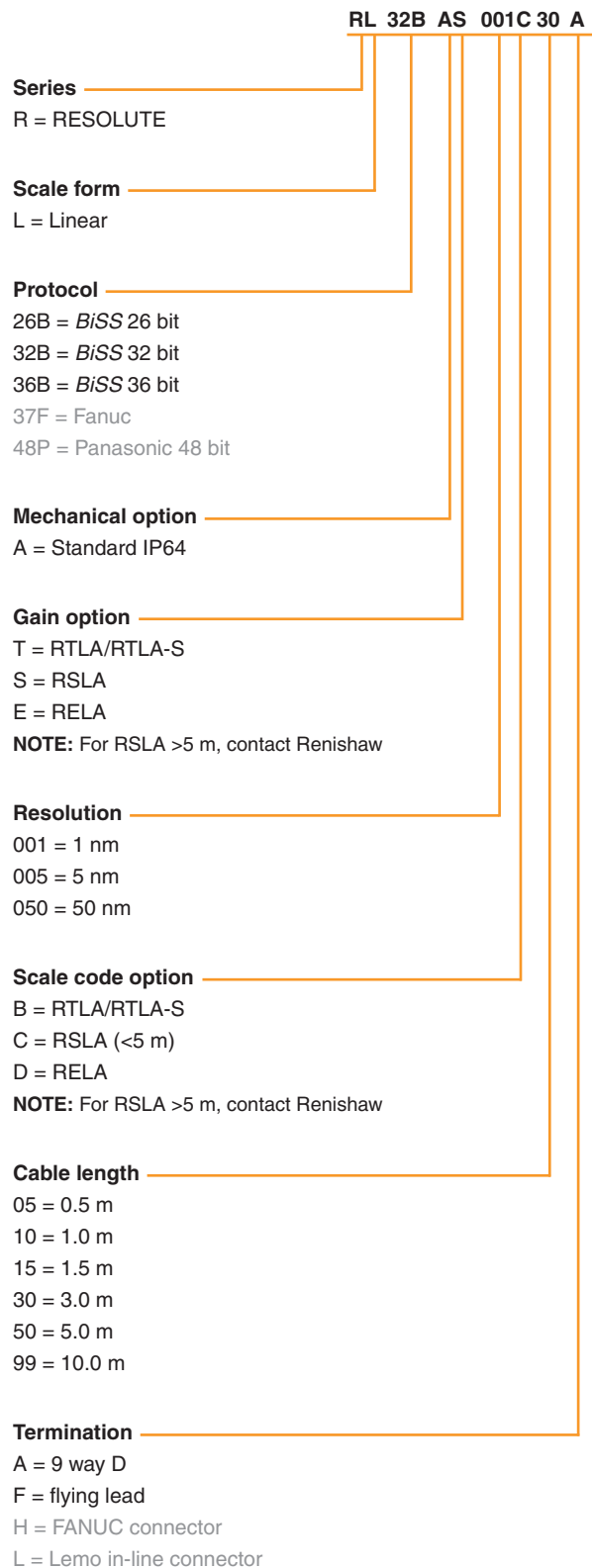

RESOLUTE installation drawing (on RSLA/RELA scale)

Dimensions and tolerances in mm

For detailed drawings, please refer to the RESOLUTE linear or rotary encoder installation guides

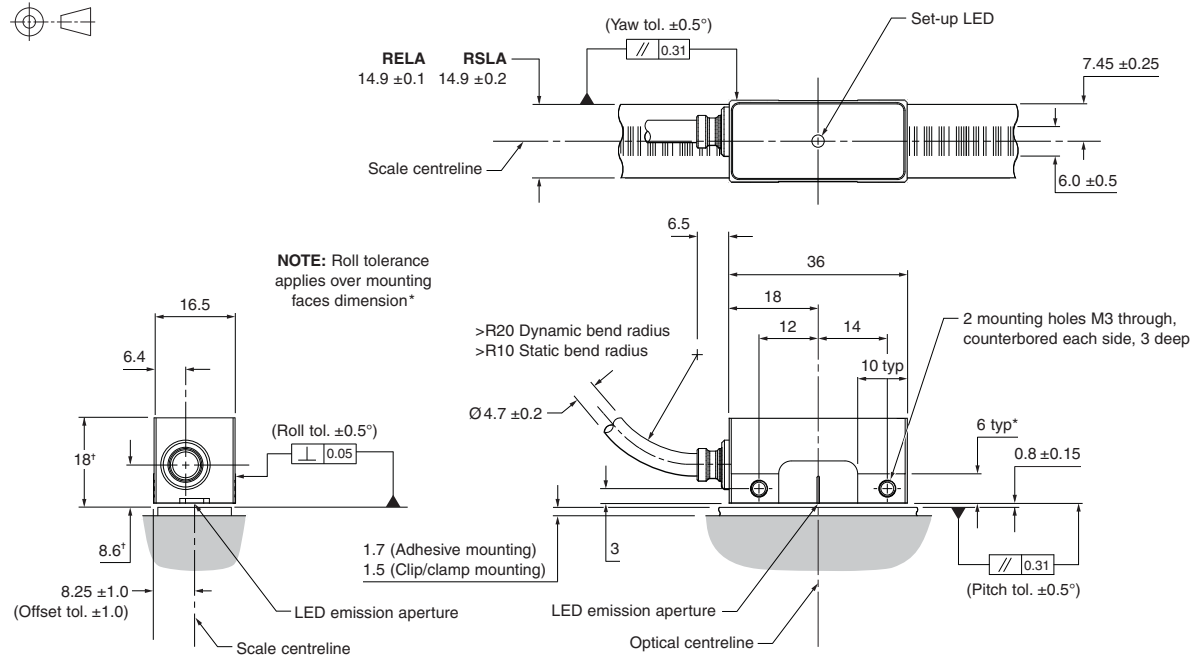

*Dimensions from scale surface

RESOLUTE compatible products:

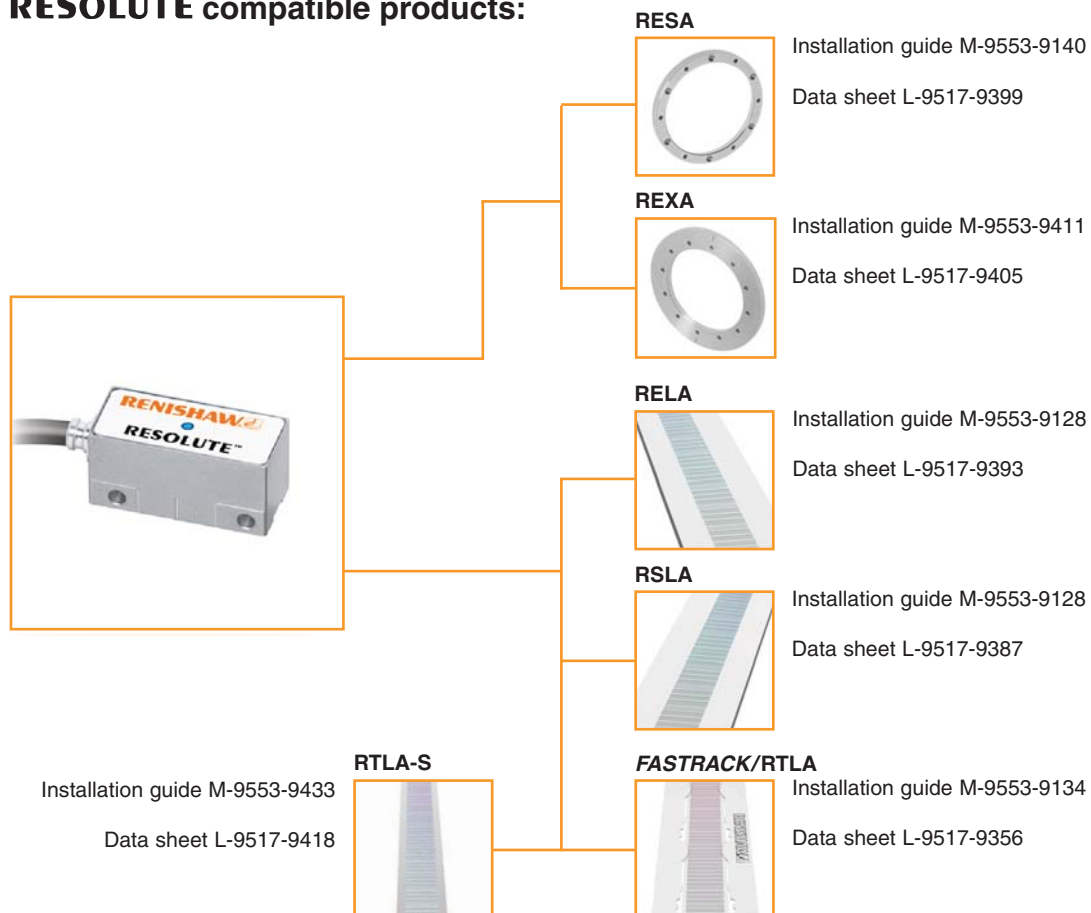

For worldwide contact details, please visit our main website at www.renishaw.com/contact

RENISHAW HAS MADE CONSIDERABLE EFFORTS TO ENSURE THE CONTENT OF THIS DOCUMENT IS CORRECT AT THE DATE OF PUBLICATION BUT MAKES NO WARRANTIES OR REPRESENTATIONS REGARDING THE CONTENT. RENISHAW EXCLUDES LIABILITY, HOWSOEVER ARISING, FOR ANY INACCURACIES IN THIS DOCUMENT.

RENISHAW® and the probe emblem used in the RENISHAW logo are registered trademarks of Renishaw plc in the UK and other countries. apply innovation is a trademark of Renishaw plc. BiSS® is a registered trademark of iC-Haus GmbH. Invar® is a registered trademark of Arcelor Mittal

© 2010-2011 Renishaw plc All rights reserved Issued 0711



L - 9517 - 9448 - 02