



MX20/MX30/MX30i MOBILE PRINTER USER MANUAL



MX20/MX30/MX30i
USER MANUAL
CONTENTS

1	Mobile Printer	001
1.1	Box Content	001
1.2	Getting to Know Your Printer	002
2	Printer Setup	004
2.1	Battery Installation	004
2.2	Paper Installation	005
2.3	Battery Charging	007
2.4	Belt Strap & Shoulder Strap Usage	008
2.5	Wizard CD Standard Installation	009
2.6	Wizard CD Other Choice Installation	012
3	Setting and Control for Operation Panel	015
3.1	Operation Panel	015
3.2	LCD Interface Introduction	017
3.3	LCD Setting Items In Setting Mode	019
3.4	Label Calibration and Self Test	020
3.5	Active / Sleep / Shutdown / Charge Mode	021
3.6	Bluetooth Connection Terminal	022
4	Accessories	023
4.1	Charger	023
4.2	Car Charger and RS-232 Cable	024
4.3	Protective Case	025
5	Maintenance and Adjustment	026
5.1	Cleaning The Thermal Print Head	026
5.2	Troubleshooting	027
	Appendix	
	Product Specifications	
	Interface	
	MX 30/30i WiFi Setting	

MX20/MX30/MX30i
USER MANUAL

FCC COMPLIANCE STATEMENT FOR AMERICAN USERS

Federal Communication Commission Interference Statement

This equipment has been tested and found to comply with the limits for a Class B digital device, pursuant to Part 15 Subpart B of the FCC Rules. These limits are designed to provide reasonable protection against harmful interference in a residential installation. This equipment generates, uses and can radiate radio frequency energy and, if not installed and used in accordance with the instructions, may cause harmful interference to radio communications. However, there is no guarantee that interference will not occur in a particular installation. If this equipment does cause harmful interference to radio or television reception, which can be determined by turning the equipment off and on, the user is encouraged to try to correct the interference by one of the following measures:

- Reorient or relocate the receiving antenna.
- Increase the separation between the equipment and receiver.
- Connect the equipment into an outlet on a circuit different from that to which the receiver is connected.
- Consult the dealer or an experienced radio/TV technician for help.

This device complies with Part 15 of the FCC Rules. Operation is subject to the following two conditions:

(1) This device may not cause harmful interference, and (2) this device must accept any interference received, including interference that may cause undesired operation.

FCC Caution: Any changes or modifications not expressly approved by the party responsible for compliance could void the user's authority to operate this equipment.

EMS AND EMI COMPLIANCE STATEMENT FOR EUROPEAN USERS

This equipment has been tested and passed with the requirements relating to electromagnetic compatibility based on the standards EN 300 328 V2.1.1(2016-11) .The equipment also tested and passed in accordance with the European Standard EN55022 for the both Radiated and Conducted emissions limits.

MX SERIES TO WHICH THIS DECLARATION RELATES IS IN CONFORMITY WITH THE FOLLOWING STANDARDS

IEC 60950-1(ed.2), IEC 60950-1(ed.2); am1, IEC 60950-1(ed.2);am2, GB4943.1-2011, GB9254-2008 , GB17625.1-2012 ; EN 300 328 V2.1.1(2016-11), UL 60950-1, 2nd Edition, 2011-12-19, CSA C22.2 No. 60950-1-07, 2nd Edition, 2011-12, FCC part 15 subpartB, NCC LP002.z

Battery Safety Precautions

Make sure to review the user manual carefully prior to product use.

Neglecting to heed the following instructions can result in battery overheating, combustion, explosion, damage and/or decline in performance and product life.

1. Do not allow water, seawater or moisture to enter or leak into the battery. If the safety mechanism within the battery becomes oxidized, oxidized the battery may overcharge with abnormal electrical current and/or voltage so that it may overheat, ignite and/or explode.
2. Do not place the battery near open flames or heating devices, such as stoves.
Exposure to excessive heat may cause damage to the resin case and/or insulating materials, thus causing a short circuit within the battery that may result in battery overheating, combustion, and/or explosion.
3. Charge the battery only with the exclusive charger specified (optionally provided) by GoDEX.
The use of an incorrect charger may result in overheating. Combustion and/or explosion of the battery.
4. Charging the battery with a modified charger may result in overheating, combustion and/or explosion of the battery by abnormal chemical reaction caused by incorrect polarity.
5. Do not directly connect the battery to an electrical power outlet not specified by GoDEX or an automobile's cigarette lighter jack. Doing so may result in overheating, combustion and/or explosion of the battery by over-current and/or over-voltage.
6. Do not heat the battery or place it near a fire. Doing so may melt insulation materials, damage the safety mechanism/equipment, and/or ignite the electrolytic solution. There is a potential risk of battery overheating, combustion, and/or explosion.
7. Do not reverse the connection of (+) and (-) electrodes of the battery. Charging the battery in reverse polarity may produce an undesired chemical reaction inside the battery cell, causing unexpected behavior during discharging such as overheating, explosion, or fire.
8. Do not allow the battery's (+) or (-) pole to come into contact with any metal. In addition, do not carry or store the battery with metallic items, such as necklaces and hairpins.
Doing so may cause a short circuit of the battery generating an over-current. There is the potential risk to overheat, ignite and/or explode the battery or overheat the metallic items, such as necklaces, hair pins etc.
9. Do not throw the battery or subject it to strong shock. If the safety mechanism in the battery is damaged, the battery may be overcharged and, consequently, an adverse chemical reaction may be generated in the battery. There is a potential risk of battery overheating, combustion, and/or explosion.
10. Do not pierce the battery with a pointed object, such as nail or awl, or strike with a heavy object, such as a hammer, and take care not to step on the battery. There is a potential risk of battery overheating, combustion, and/or explosion caused by an internal short circuit.
11. Do not solder the battery directly. Doing so may melt the insulating materials and/or damage the safety mechanism or safety equipment, resulting in battery overheating, combustion, and/or explosion.
12. Do not disassemble and/or modify the battery. The battery contains safety equipment and a safety mechanism to prevent danger. There is a potential risk of overheating, combustion, and/or explosion caused by disassembly.
13. Do not charge the battery near open flames and/or under direct sunlight. Charging the ambient temperature at 0°C ~ 40°C. Because exposure to high temperatures triggers the operation of the safety mechanism, the battery may not charge or may overcharge due to destruction of the safety mechanism. There is a potential risk of overheating, combustion, and/or explosion.
14. Do not expose the battery to high temperatures over 60°C, and do not use or store it in a hot or humid place.
15. Danger of explosion if battery is incorrectly replaced. Replace only with the equivalent type recommended by the manufacturer.
16. Dispose of used batteries according to the manufacturer's instructions.
17. Only use with designated power supply adapter model.
18. Changes or modifications not expressly approved by the party responsible for compliance could void the user's authority to operate the equipment.

1 Mobile Printer

1.1 Box Content

Please check that all of the following items are included with your printer.
Charge the battery for at least 3 hours before use.

- MX20 / MX30 / MX30i Mobile Printer

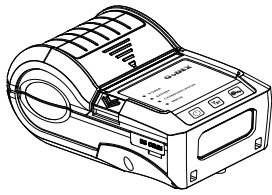

MX20

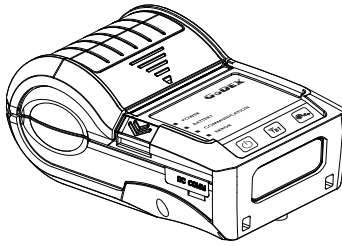

MX30

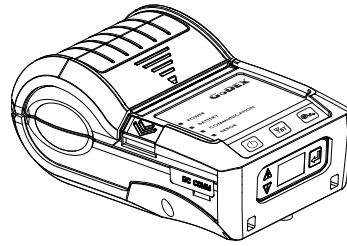

MX30i

- Thermal Paper



- Belt Strap(MX20 Series)

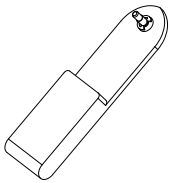

- Shoulder Strap(MX30 Series)

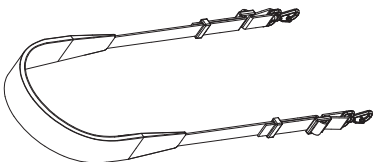

- Lithium Battery

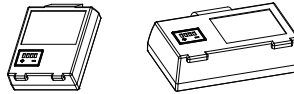

MX20 Series MX30 Series

- Power Supply

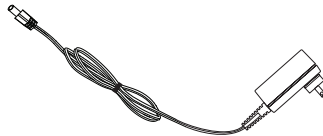

- USB Cable

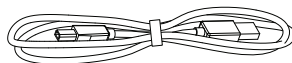

- MX20 / MX30 / MX30i Series Quick Guide



- CD
Including GoLabel software
and MX series user's manual.

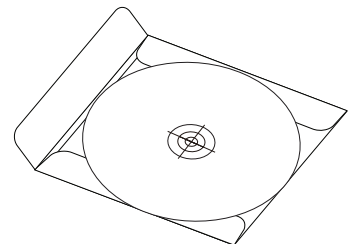

1 Mobile Printer

1.2 Getting to Know Your Printer

Device Overview

Front View (Take MX30i as an example)

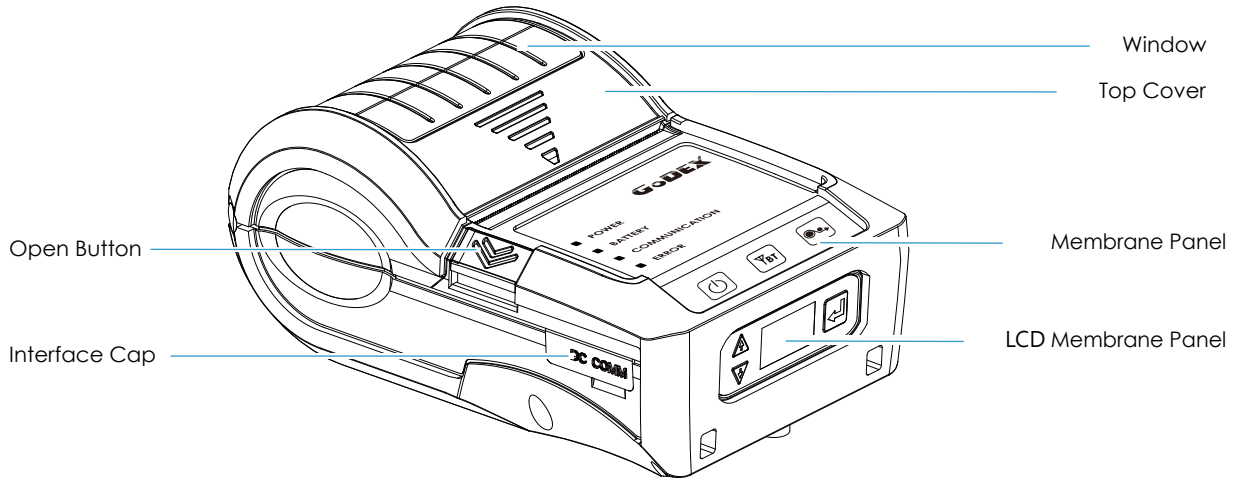

- **Rear View**

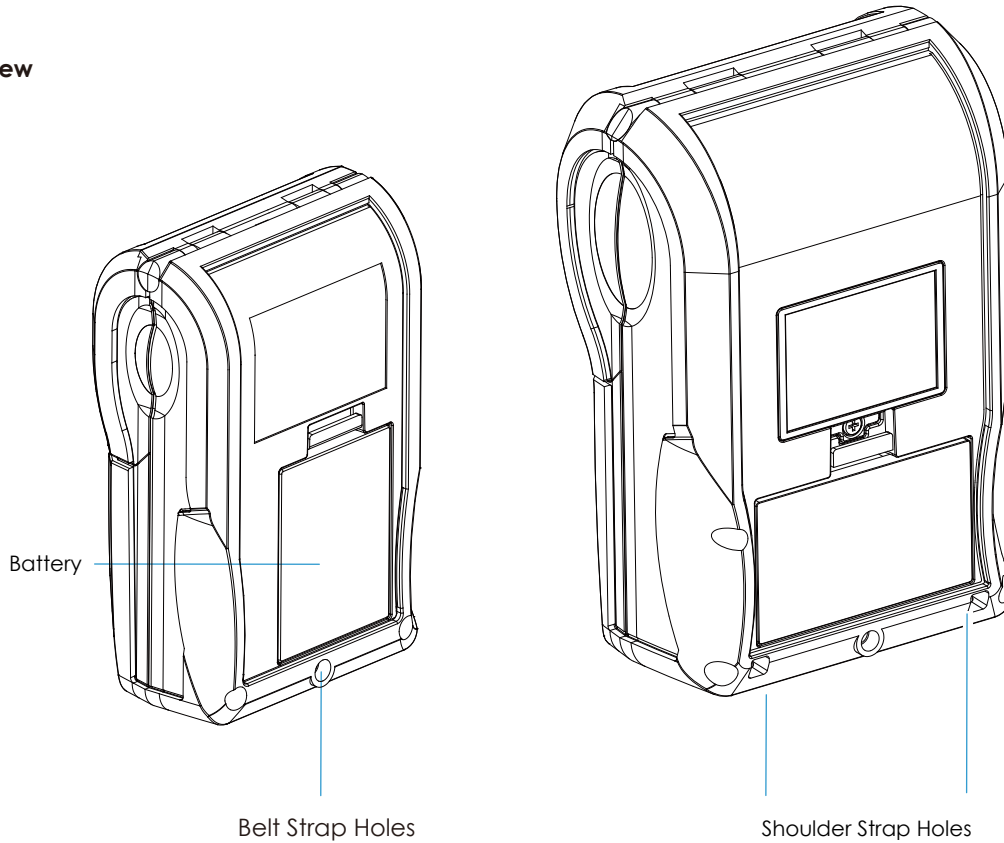

MX20 Series

MX30 Series

1 Mobile Printer

The Internal View of the Printer (Take MX30i as an example)

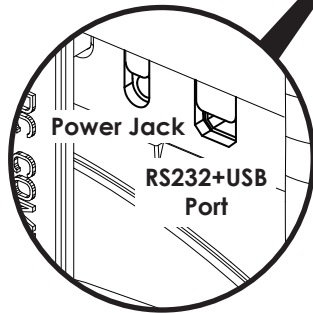
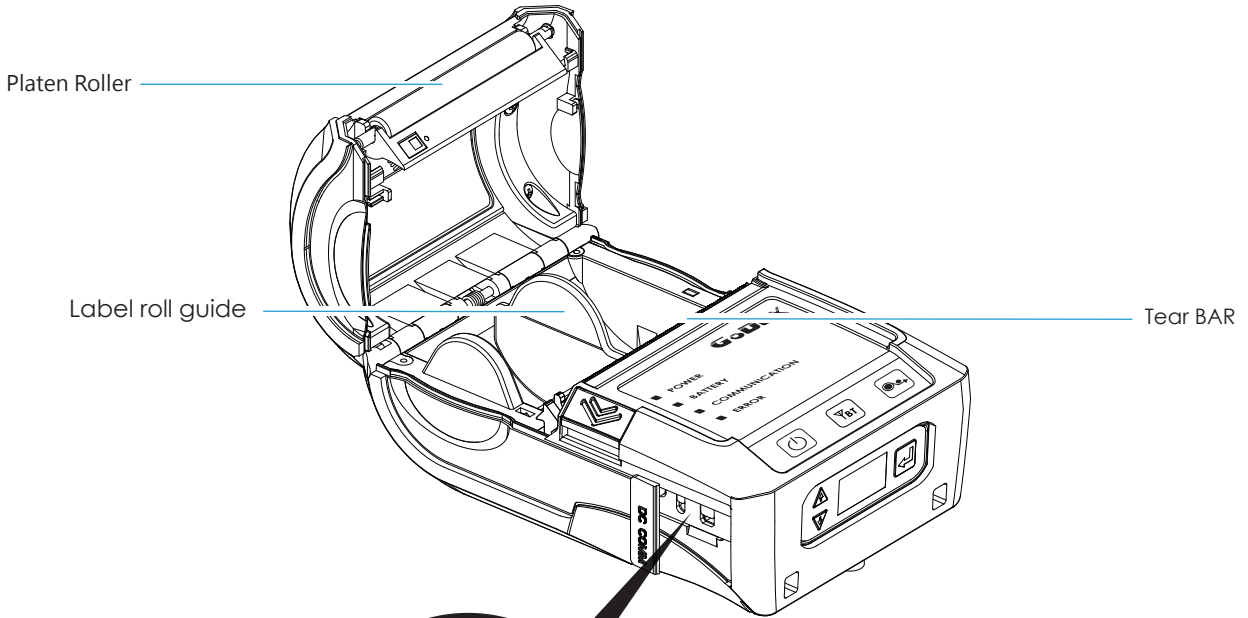

This RS232 & USB Port only support signal transmission, no charge function.

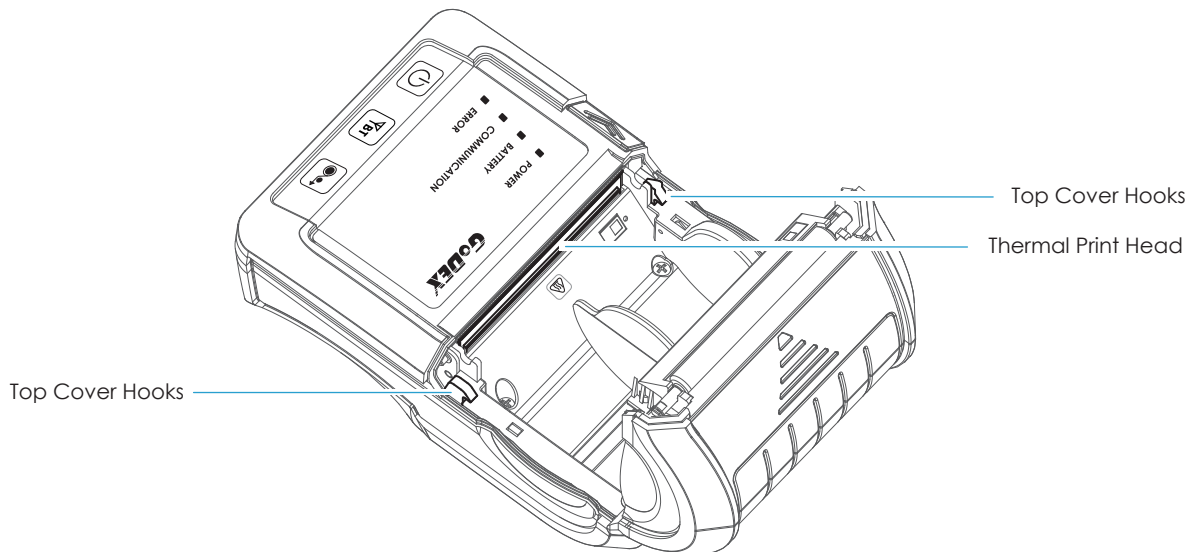

2 Printer Setup

2.1 Battery Installation

Make sure to charge the battery for at least 3 hours prior to first use.

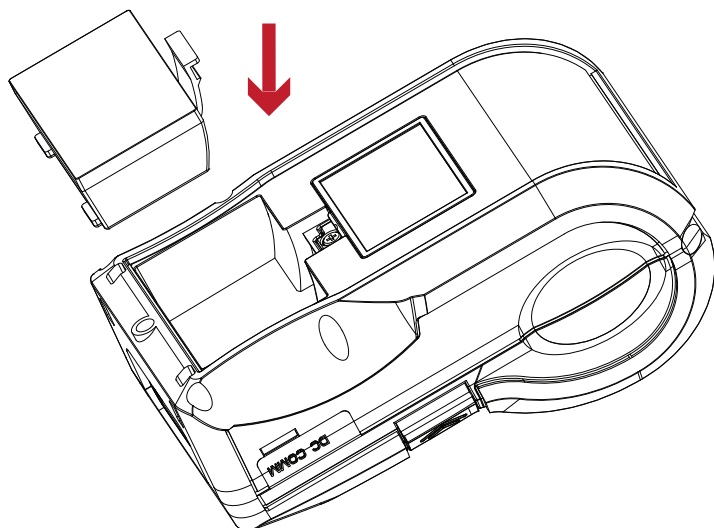

Insert the battery on the rear side of the printer, aligning the battery hook properly. Push the battery into the slot until you hear a clicking sound.

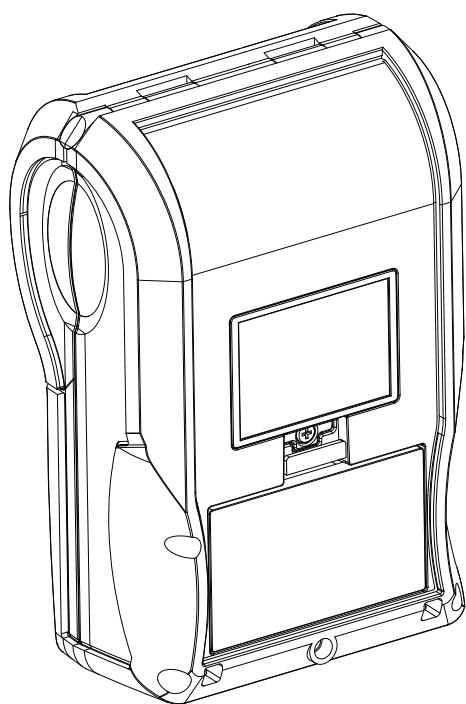

Battery installation completed

2 Printer Setup

2.2 Paper Installation

The printer is set to Direct thermal transfer so no ribbon is required.

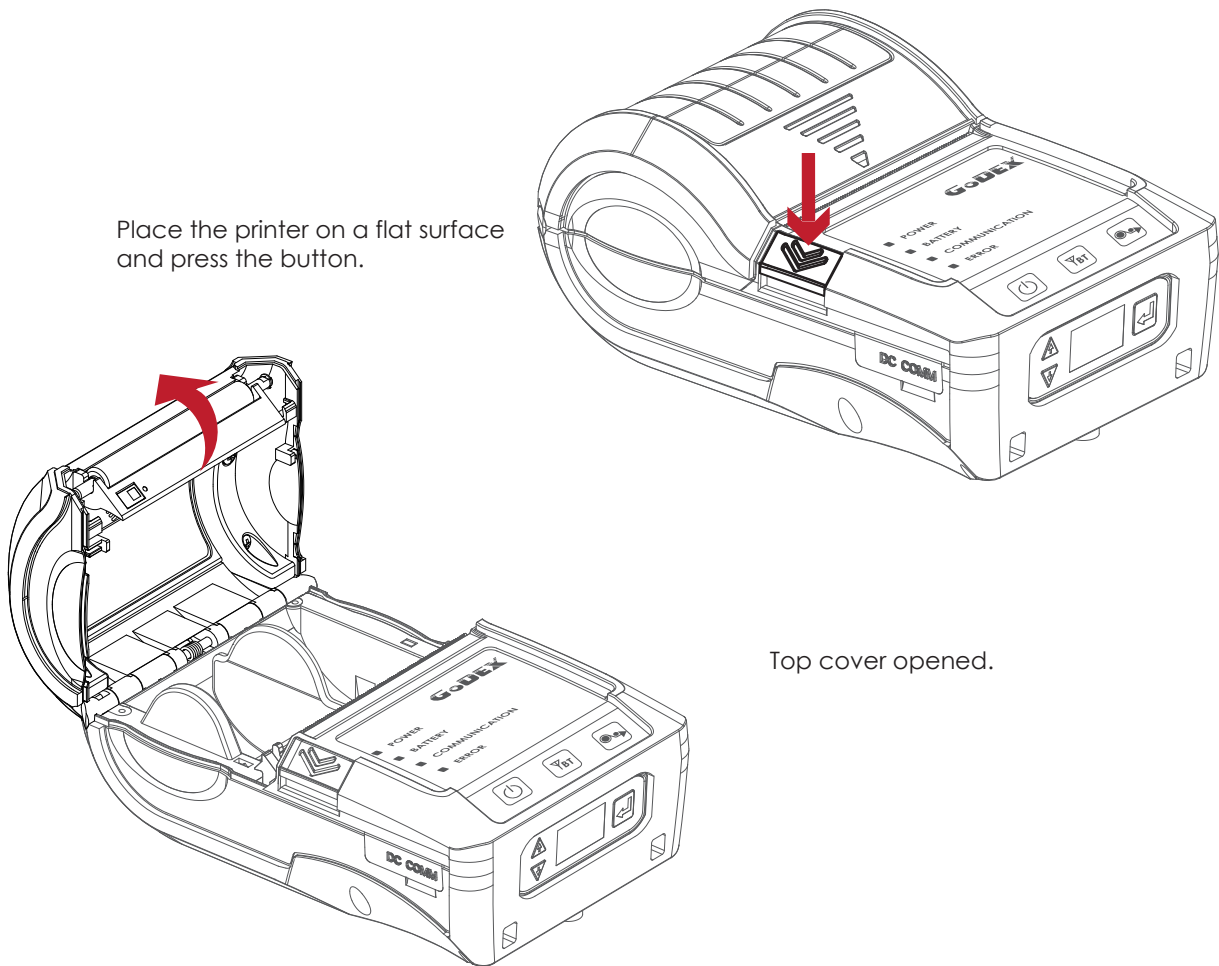

2 Printer Setup

Insert the paper as shown in the image.

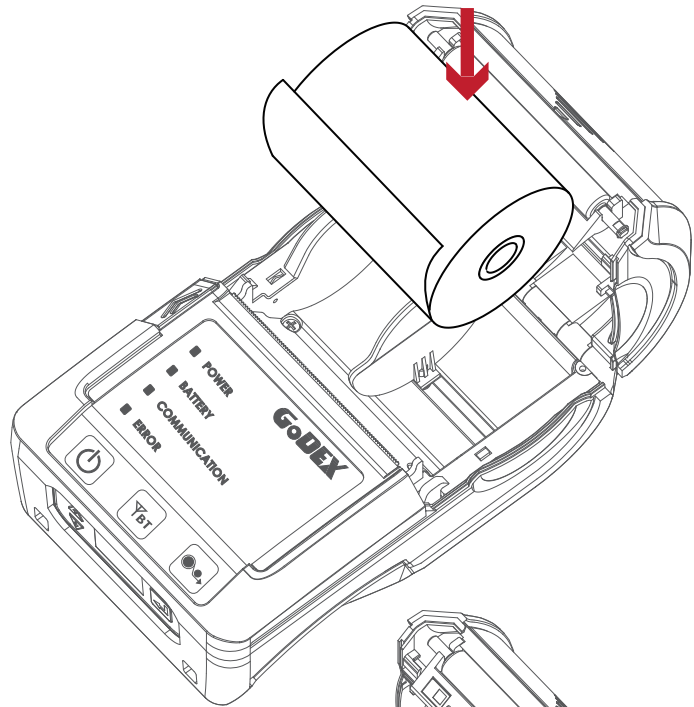
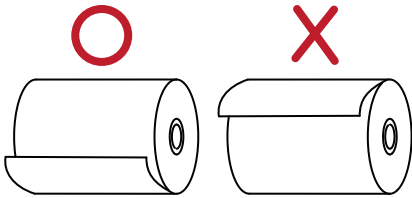

Pull the paper out and close the paper cover.

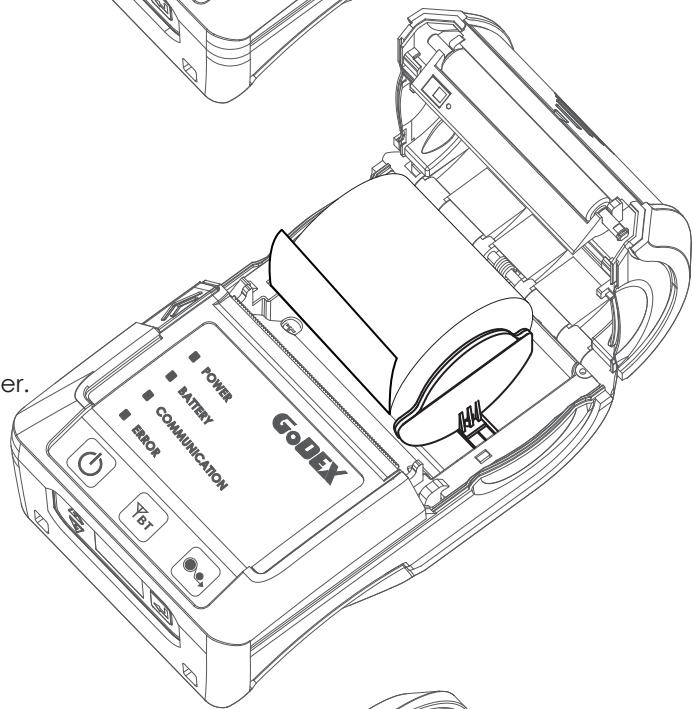

Tear off any excess paper in the direction of the side of the printer.

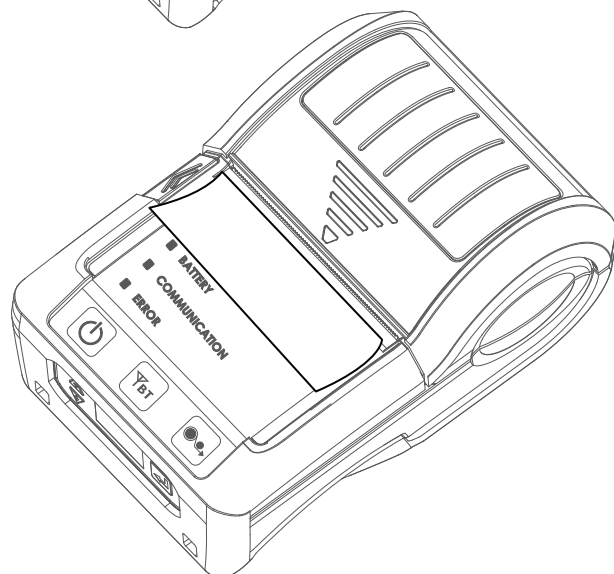

Note

* When you move label roll guide, try to force near its bottom.

2 Printer Setup

2.3 Battery Charging

1. Please make sure that the printer is switched off.
2. Connect the jack of the power adapter to the printer and connect the plug of the power adapter to the socket of the wall.
3. Turn on the printer. The operator panel should now light up.

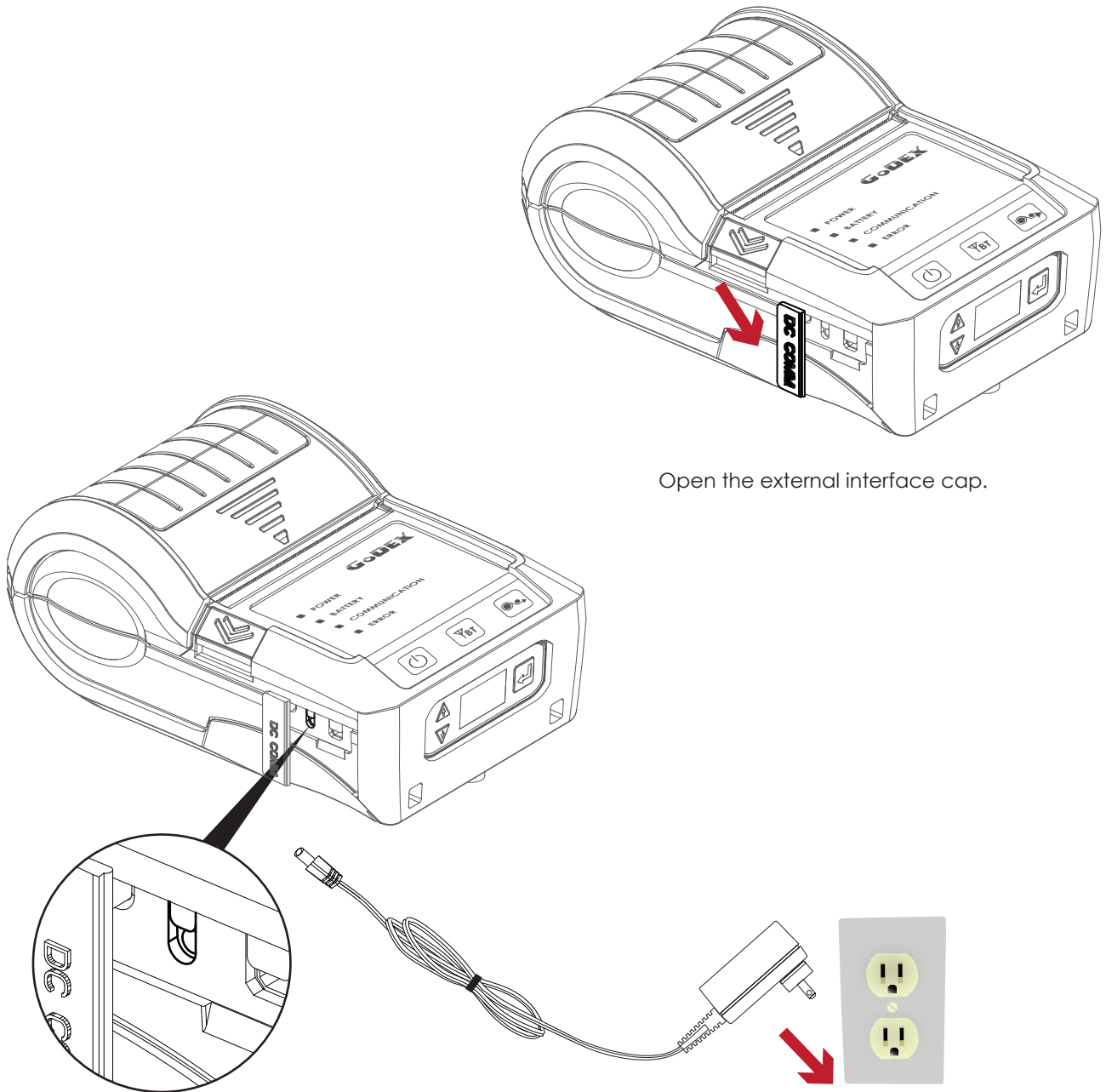

Open the external interface cap.

Note

* Charge the battery around 3 hours before use please. Charging the ambient temperature at 0°C ~ 40°C.

** Closed the external interface cap when printer do not connect an adapter or cable for avoid dust away.

2 Printer Setup

2.4 Belt Strap & Shoulder Strap Usage

MX20 Series

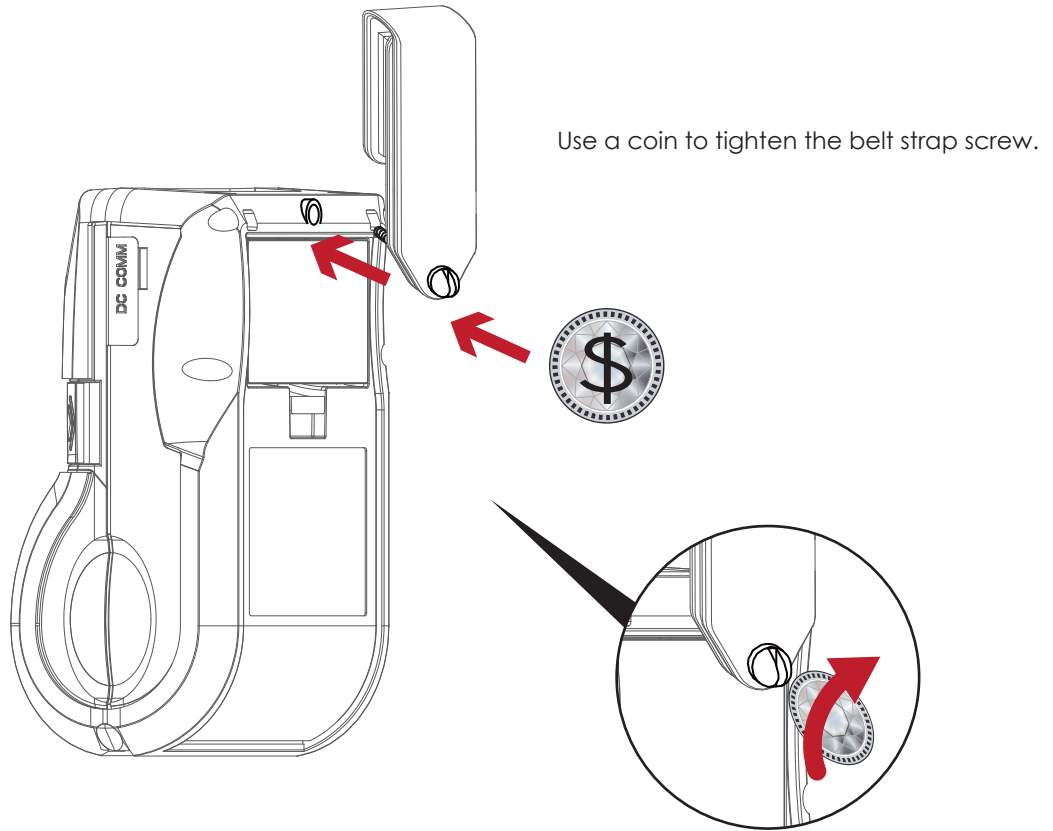

MX30 Series

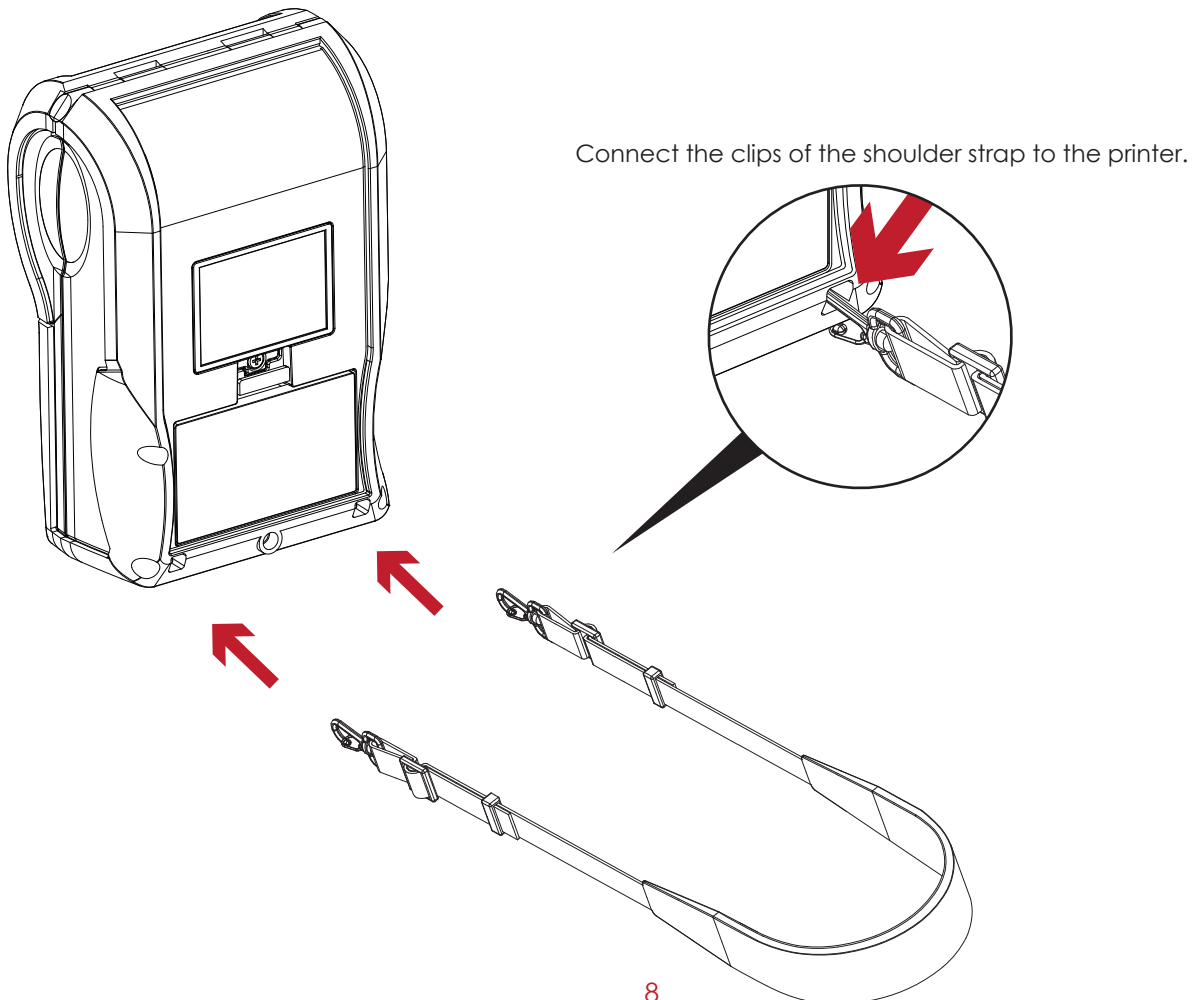

2 Printer Setup

2.5 Wizard CD Standard Installation

1. Insert the Super Wizard CD in the CD/DVD drive of the host computer and the installation program should pop up automatically.
You will see the Welcome screen first. On the Welcome screen, choose "STANDARD INSTALLATION".

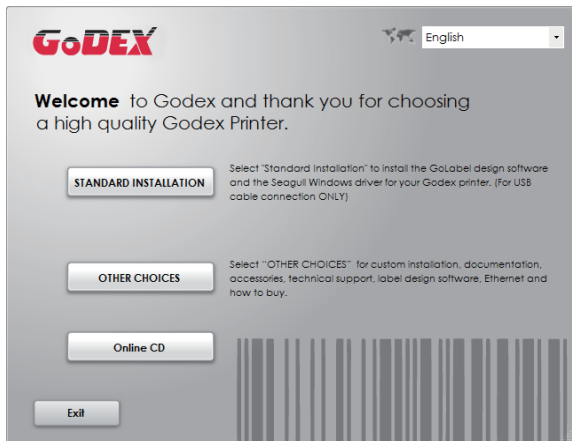

2. The wizard will then ask you to make sure your USB and power cables are connected and that the power is turned on. Then click "NEXT".



3. The next screen you will see is, "Install the GoLabel Software and Windows driver". Click "NEXT" to continue.



Note

* If the Super Wizard program did not run automatically, you can either turn on the "Auto-run" setting for your CD/DVD driver or double-click the icon of CD/DVD driver to run the program manually.

2 Printer Setup

- As the printer driver and GoLabel are installing, a screen will display a progress bar. While downloading completed you will see Installation completed. Click "NEXT" to continue.



- You can also print a test label. If don't print a test label, the screen display as step 6.

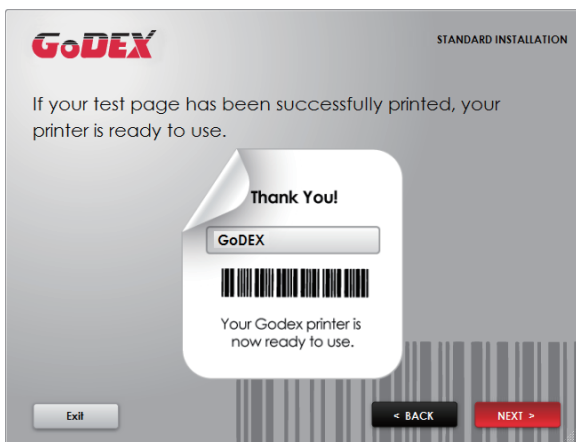
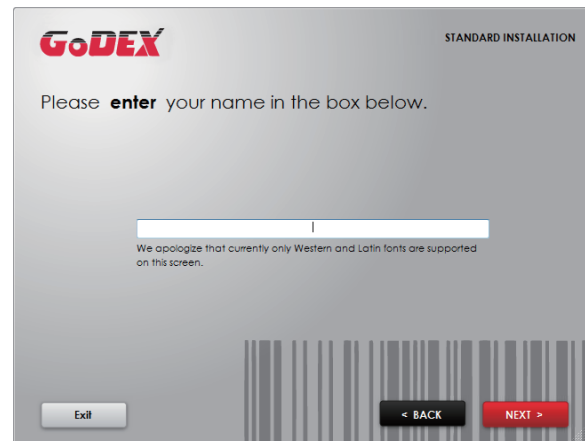
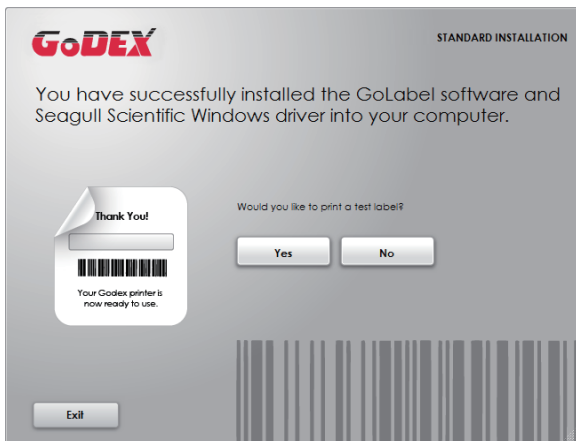

Note

* If you need more resources, tools or reference documents, you can also find them on Super Wizard CD. Just click "Other Choices" on the Welcome Screen to access the files.

2 Printer Setup

6. Once the installation is complete, you can start to make and print labels with GoLabel or through the printer driver.

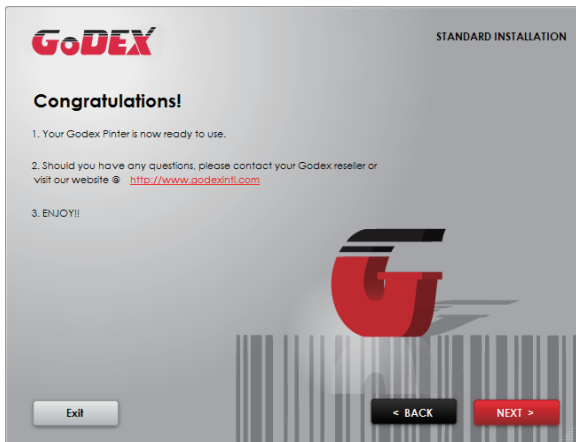

2 Printer Setup

2.6 Wizard CD Other Choice Installation

1. Click "OTHER CHOICES" to next screen and select "PRINTER DRIVERS".

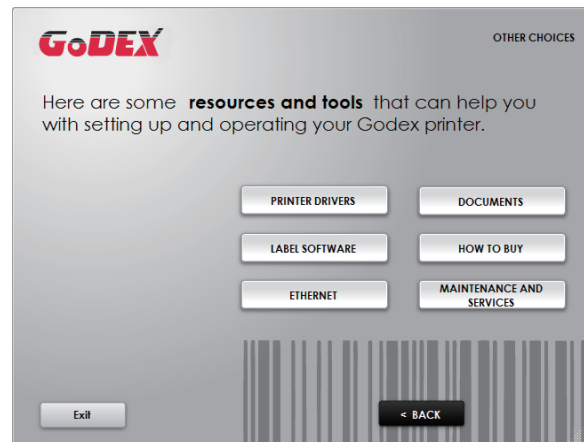
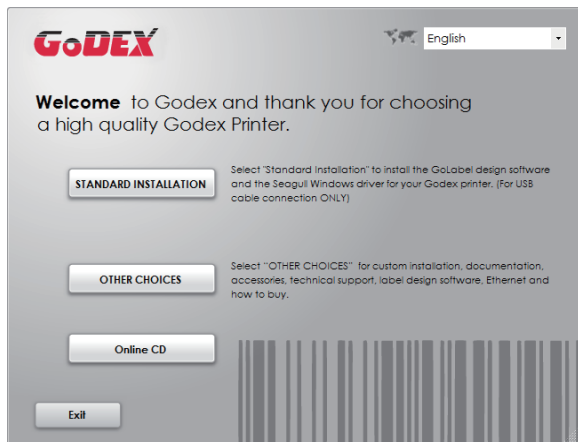

2. Click "INSTALL SEAGULL SCIENTIFIC WINDOWS DRIVER" to next screen, and click "NEXT".

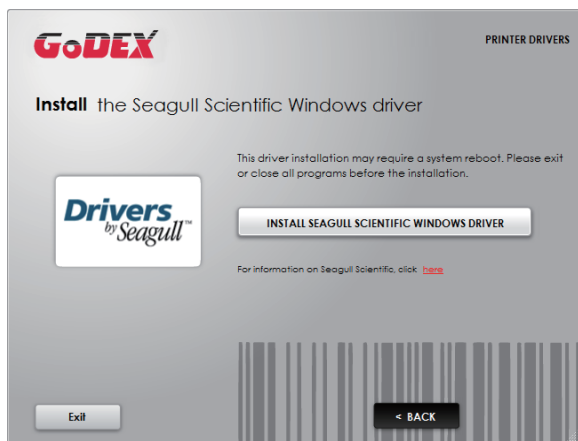

3. Select "I accept the terms in the license agreement", and click "Next" · then click "Finish" to step 4.

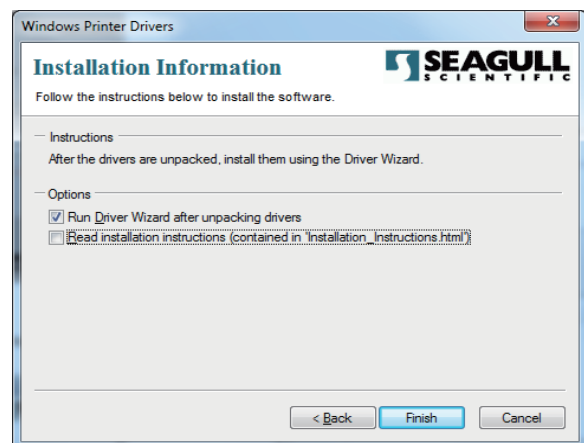
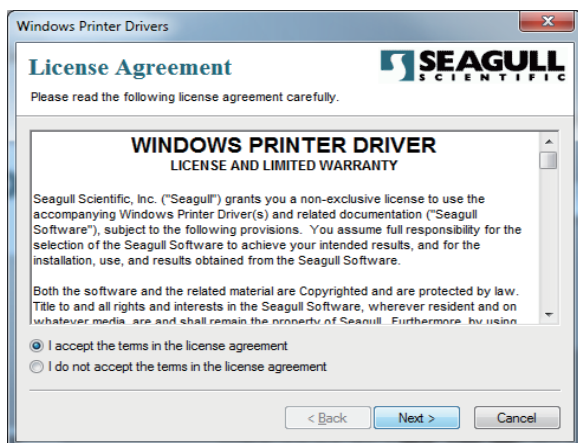

2 Printer Setup

4. The Driver Wizard will guide you through the installation procedure. Select "Install printer drivers" and click "Next".



5. With a USB connection, search models such as the right diagram printer device. Specify your printer model and click "Next".

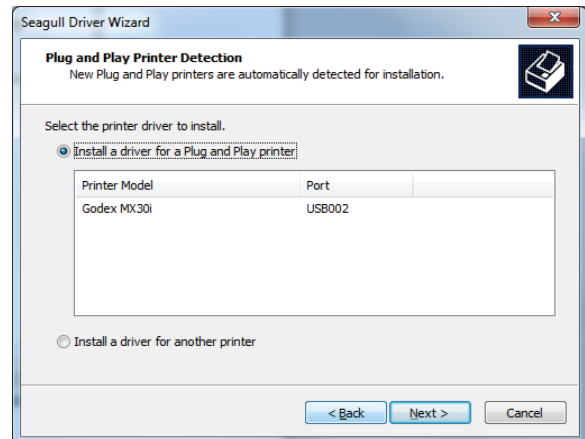
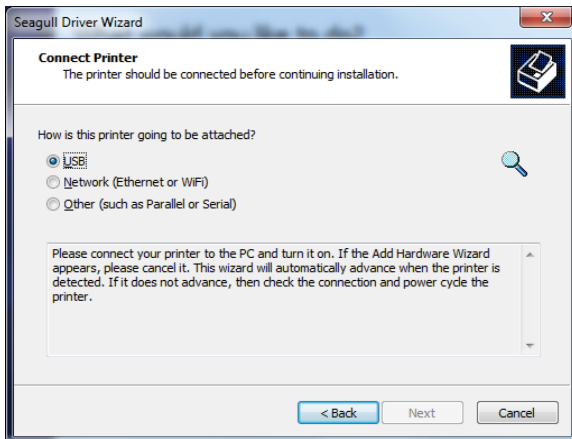

6. Enter the printer name (you can use default), then click "Next" to display as right diagram. Click "Finish" button to start installation.

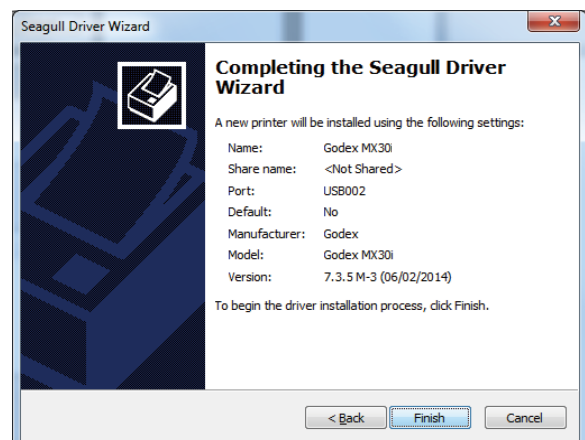
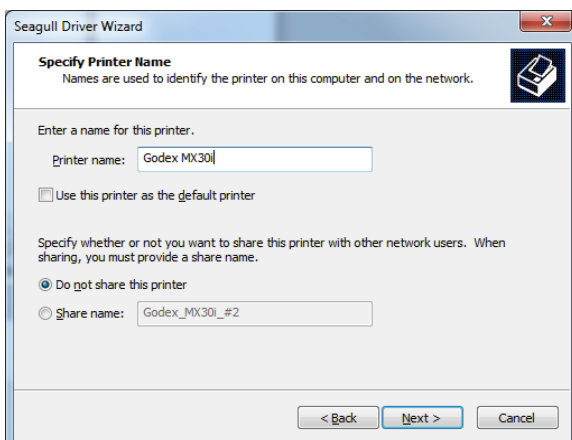

2 Printer Setup

7. Driver installation completed.

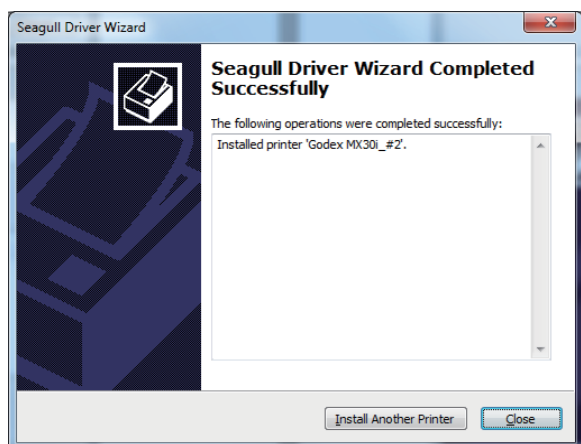

3 Setting and Control for Operation Panel

3.1 Operation Panel

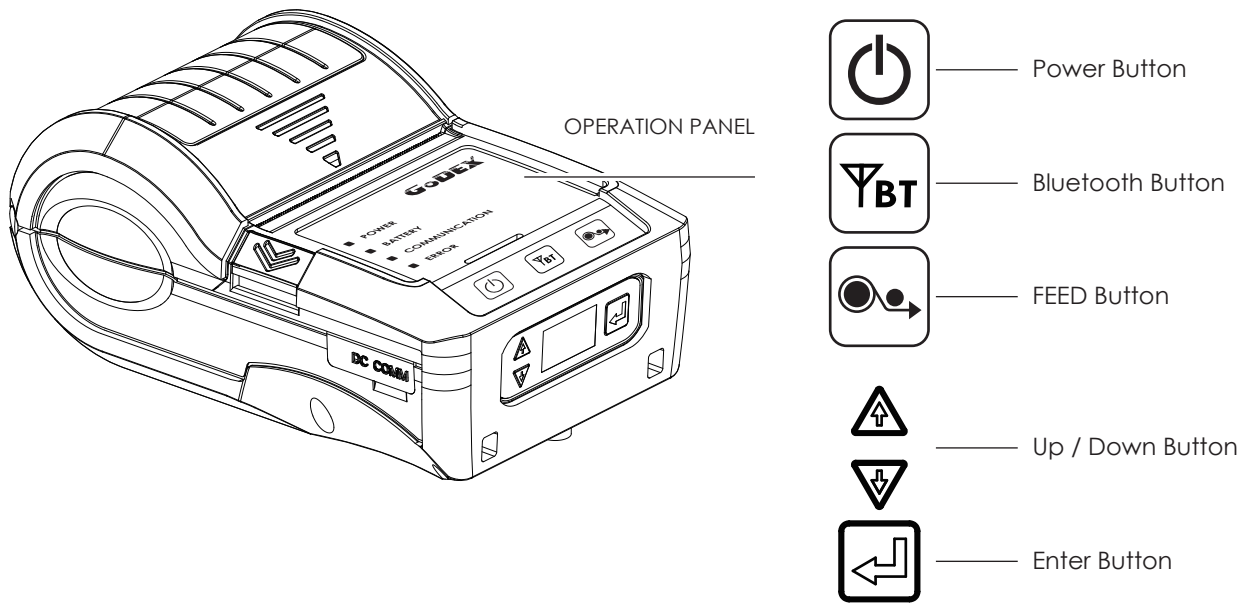

POWER Button

Press the POWER button to turn on the printer, and the POWER LED signal lights appears. While hear one “Beep sound” , the LCD screen should display the message “GoDEX“ Logo on the screen.

When printer is turned on, hold and press down the POWER button for 3 second will turn the printer off.

FEED Button

Turn on the printer and press the FEED button.

When you press the FEED button, the printer will advance media until the FEED button is released.

If you are using continuous labels, pressing the FEED button will advance a length of media until the button is released.

If you are using media with gaps, pressing the FEED button once will advance only one label.

If the label does not stop at the correct position, you need to run the auto-detection function for your media, please see Section 3.4 Label Calibration and Self-Test.

PAUSE PRINTING_FEED Button





Pressing the FEED button during printing will interrupt printing. While Error LED flash, the printer can't receive commands. When the FEED button is pressed again, the printer resumes printing. Example: While a 10-label print job is running, you press the FEED button to pause the printer. Two of the labels have been printed. To resume printing and print the remaining eight labels, you will need to press the FEED button again.









CANCEL PRINTING_FEED Button

Press and hold the FEED button for 3 seconds during printing cancels a print job. The current print job is cancelled. Example: While a 10-label print job is running, you press the FEED button. Two of the labels have been printed. The print job is cancelled and the remaining eight labels will not be printed.

3 Setting and Control for Operation Panel

4 dual-color LED - Power On, Battery Capacity, Status Information (Wireless) , Status Information (Media):

 POWER  BATTERY  COMMUNICATION  ERROR

POWER	OFF	Turn off
		Turn on
BATTERY	OFF	Without battery Power off
		Battery power supply as normal Recharge finished
		Standby Mode (5 sec flash one time)
		Battery is recharging
		Battery must be charged or replaced
COMMUNICATION	OFF	No connection No data transmission
		Bluetooth ON
		Transferring data
Automatic recovery after troubleshooting. Or push FEED button to clean up error status.		
ERROR	OFF	No
		Paper out Door open Label sensing error
		Printhead overheating

3 Setting and Control for Operation Panel

3.2 LCD Interface Introduction

Getting Started

Press the POWER button to turn on the printer, and the START UP SCREEN appears.

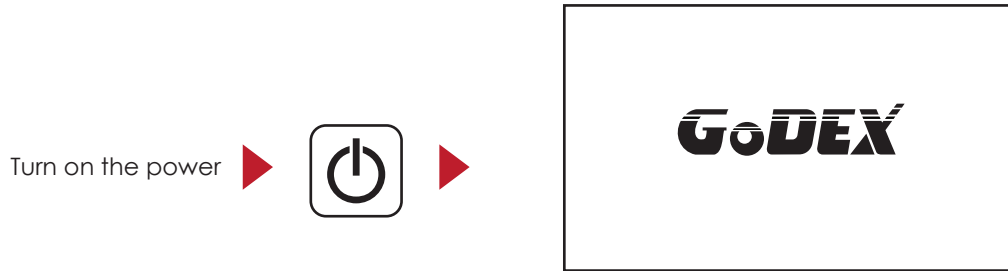



After the printer starts, GoDEX Logo will appear on the LCD screen, which means that the printer is ready to print in the state. Use the printer's user interface can perform various operation, such action is set on the main screen.

3 Setting and Control for Operation Panel

Operations on Setting Page

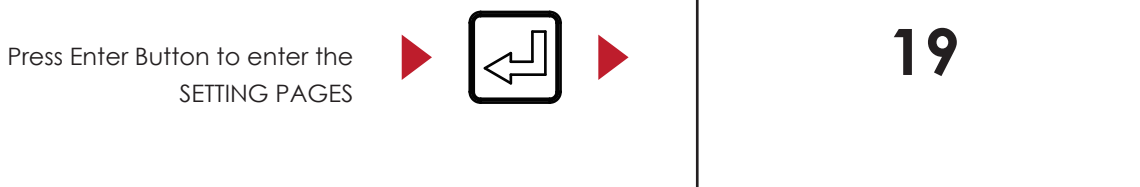
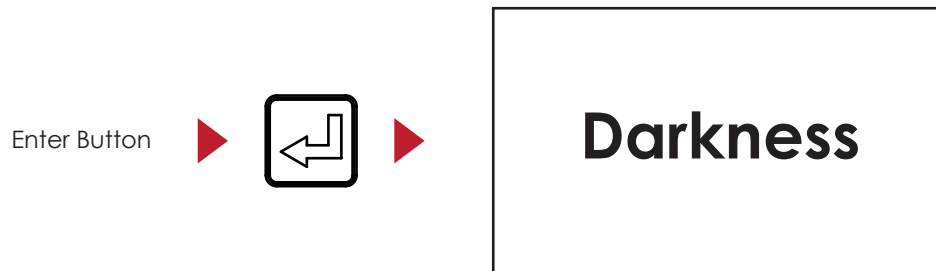
On GoDEX page, press Enter Button, you will enter the SETTING PAGES for the function.



On SETTING PAGES, press  to select the setting items, you will enter the SETTING VALUE PAGES for the function.

Press  back to previous page.

3 Setting and Control for Operation Panel

3.3 Setting Items in Setting Mode

	Self Test	Activate
	Darkness	0-19
	ADJUST STOP POSITION	0-10
	SENSOR	Media Type
		Reflective
		See-Through
		Auto
	LCD Language	English
		簡體中文
		繁體中文
		Español
		Italiano
		Deutsch
		Français
		Türkçe
		日本語
	Code Page	850
		852
		437
		860
		863
		865
		857
		861
		862
		855
		866
		737
		851
		869
		Windows 1250
		Windows 1251
		Windows 1252
		Windows 1253
		Windows 1254
		Windows 1255
		Windows 1257
	BUZZER	Off
		On
	TOP OF FORM	Off
		On
	COM PORT	4800
		9600
		19200
		38400
		57600
		115200
		Baud Rate
		None
		Odd
		Even
		Data Bits
		7
		8
		Stop Bits
		1
		2

3 Setting and Control for Operation Panel

3.4 Label Calibration and Self Test

Label Calibration

The printer can automatically detect and store label height. That means the host computer does not need to transmit the label height to the printer.

Self Test

Self-test function lets you check whether the printer is functioning normally. Here is how you run the label size calibration and self test.

1. Check that the label stock is loaded correctly.
2. Turn off the printer and pressing the FEED button.
3. Turn on the printer again, while pressing the FEED button. After waiting for the buzzer sounds twice, the printer will now measure the label stock and store the label height.
4. Once the printer has successfully calibrated the label stock, it will print a self-test label.

The contents of a self-test printout are listed below.

Model & Version	MX30i:VX.XXX
USB ID setting	USB S/N:12345678
Serial port setting	Serial port:96,N,8,1
Port status	PORT State L S E U B
(The default value is 1, which means that all ports open)	1 1 1 1 1
	#####
Number of forms	0000 FORM(S) IN MEMORY
Number of graphics	0000 GRAPHIC(S) IN MEMORY
Number of fonts	000 FONT(S) IN MEMORY
Number of Asian fonts	000 ASIAN FONT(S) IN MEMORY
Number of Databases	000 DATABASE(S) IN MEMORY
Number of Scalable fonts	000 TTF(S) IN MEMORY
Free memory size	16616 KB FREE MEMORY
Speed, Density, Ref. Point, Print direction	^S2 ^H19 ^R000 ~R200 ~Q+0
Label width, Form length, Stop position	^W72 ^Q50,3 ^E10
Cutter, Label Dispenser, Mode	Option:^D0 ^O0 ^AD
Sensor Setting	See:0.9 1.1 1.0[0.2_14]
Code Page	Code Page:850

3 Setting and Control for Operation Panel

3.5 Active / Sleep / Shutdown / Charge Mode

Sleep Mode = LED active. Power saving model.

Active Mode :

All functions active. On active mode, receiving a print job. Go to Sleep mode if no operation over 30~3600 seconds in Active mode.

Sleep Mode :

Only FEED button functions active. Go to Shutdown mode if no operation and over 30~3600 seconds to forever in Sleep mode.

Shutdown Mode :

All function off except Power button and battery charge. Wake up to Sleep mode by pressing the Power button.

Charge Mode :

Only charge function active when the battery is charging. When battery is fully charged, the battery LED will turn green.

3 Setting and Control for Operation Panel

3.6 Bluetooth Connection Terminal

The printer can be connected to devices equipped with Bluetooth communication capability.

1. Press power button to turn on the printer.
2. Press Bluetooth button, bluetooth function is turned. So that the printer can be searched.
Terminal Equipment (Bluetooth function of the device must be turned on)

Pair with another Bluetooth device.

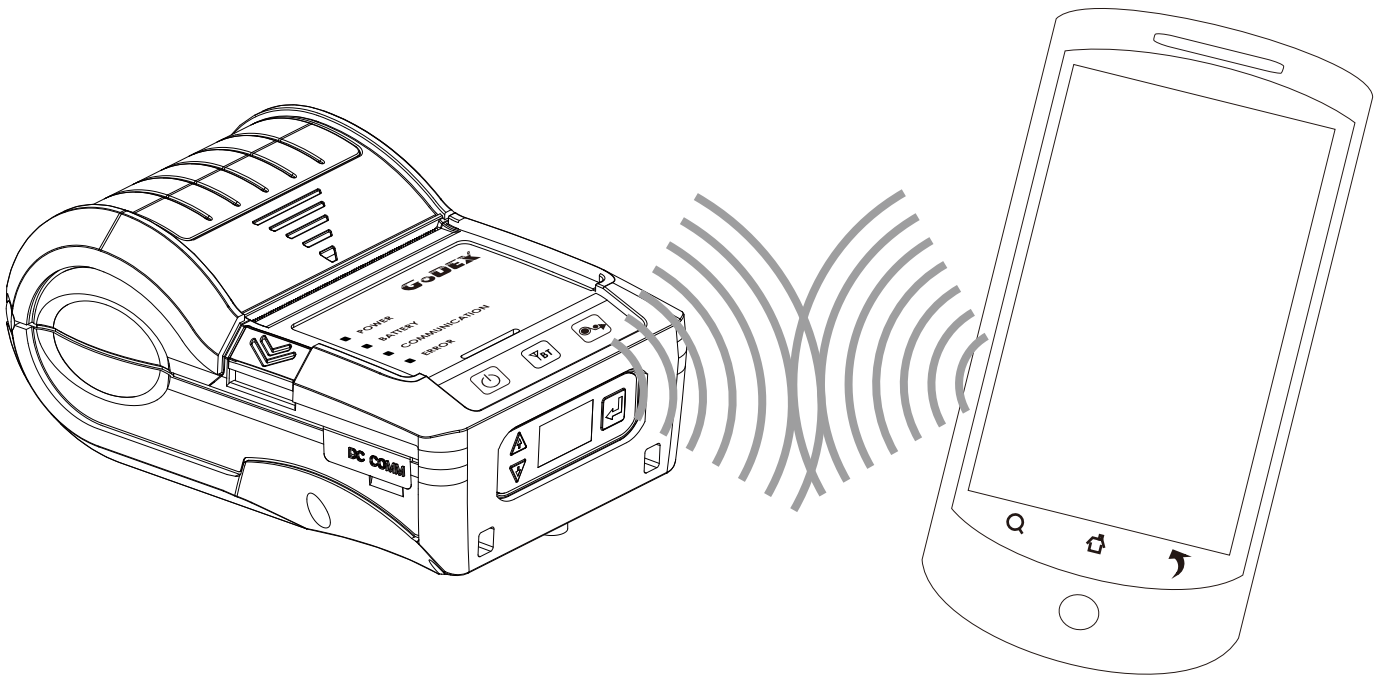

Note:



Do not press Bluetooth button while downloading and returning information through standard com port or Bluetooth, otherwise the information may lose and malfunction of printer may occur.

4 Accessories

4.1 Charger

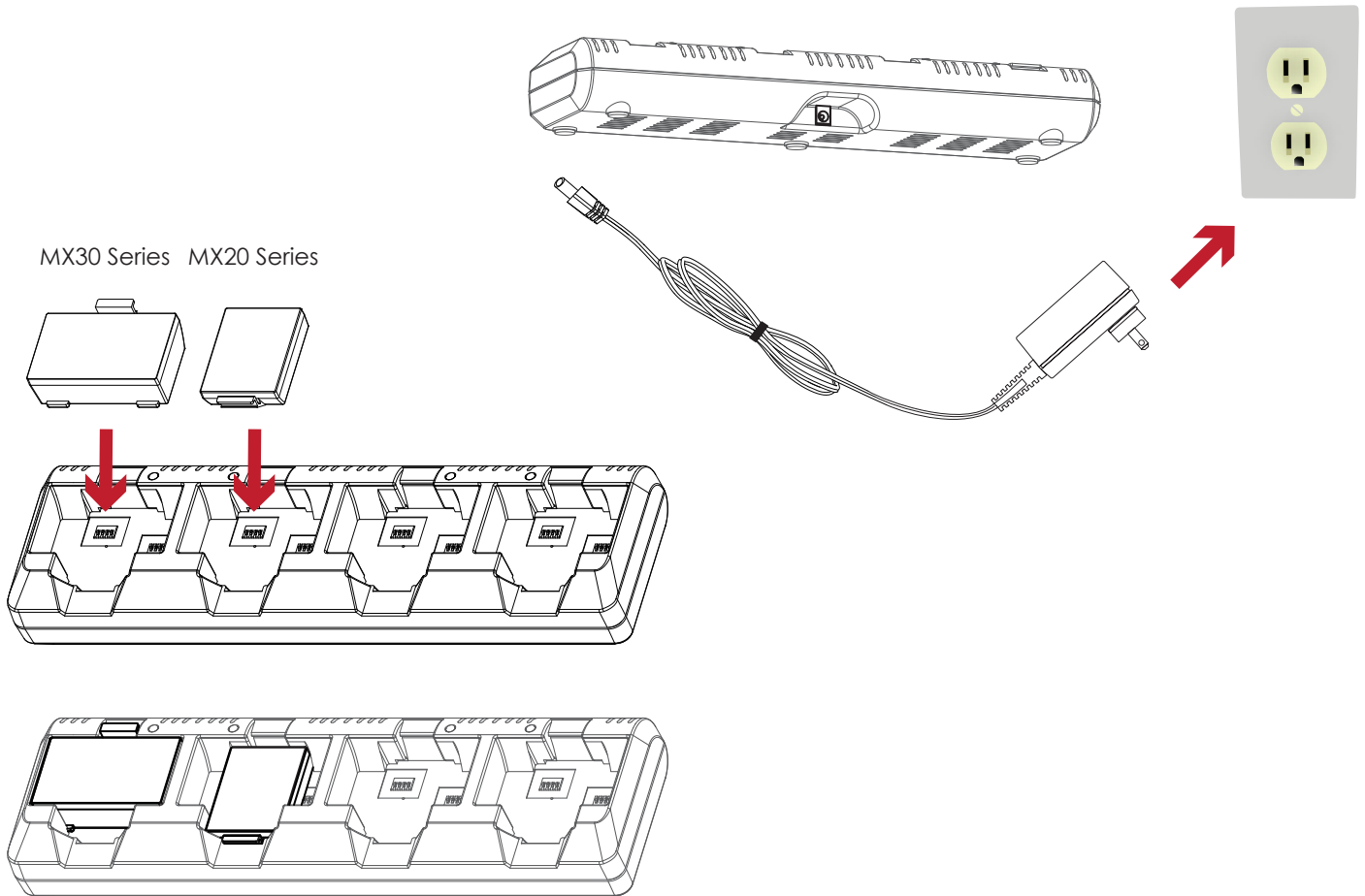
1. Connect the AC adapter to the Charger.
2. Insert the battery into the Charger as shown in the figure the below.
3. Gently slide the battery until it reaches the bottom of the charger.
4. Charging starts as soon as the battery is completely inserted.



	Light	Charge Status	Charge Time
	Red Light On	Charging	
	Green Light On	Fully Charged	Within 3 hours
	Red Light Blinking	Battery Defective	

Note

- * If the red light of the charger blinks, install the battery again.
- ** If the red light continues to blink despite several attempts(4~5 times) to install the battery, contact your local dealer.
- *** The charging time may vary depending on the type of the charger or room temperature.
- ****This battery has a protection mechanism in the battery overcharge or over discharge.

4 Accessories

4.2 Car Charger and RS-232 Cable

1. Please make sure that the printer is switched off.
(Connect the car charger to your car's cigarette lighter jack.)
2. Open the external interface protection cap.
3. Connect the mini USB cable(battery charger) to the power connector.

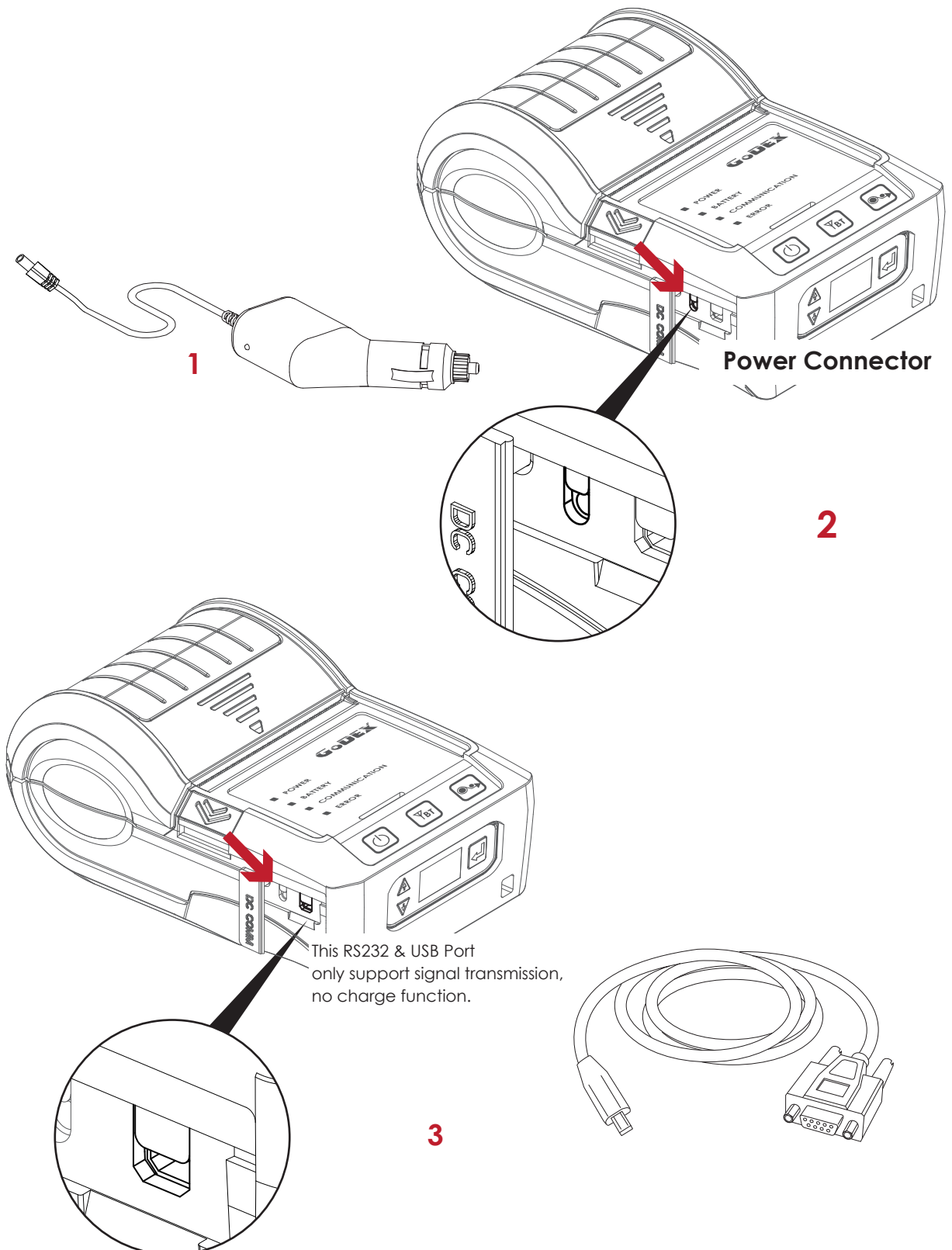

4 Accessories

4.3 Protective Case

Unzip to open up the protective case and insert your printer into the protective case as shown in the figure on the below.

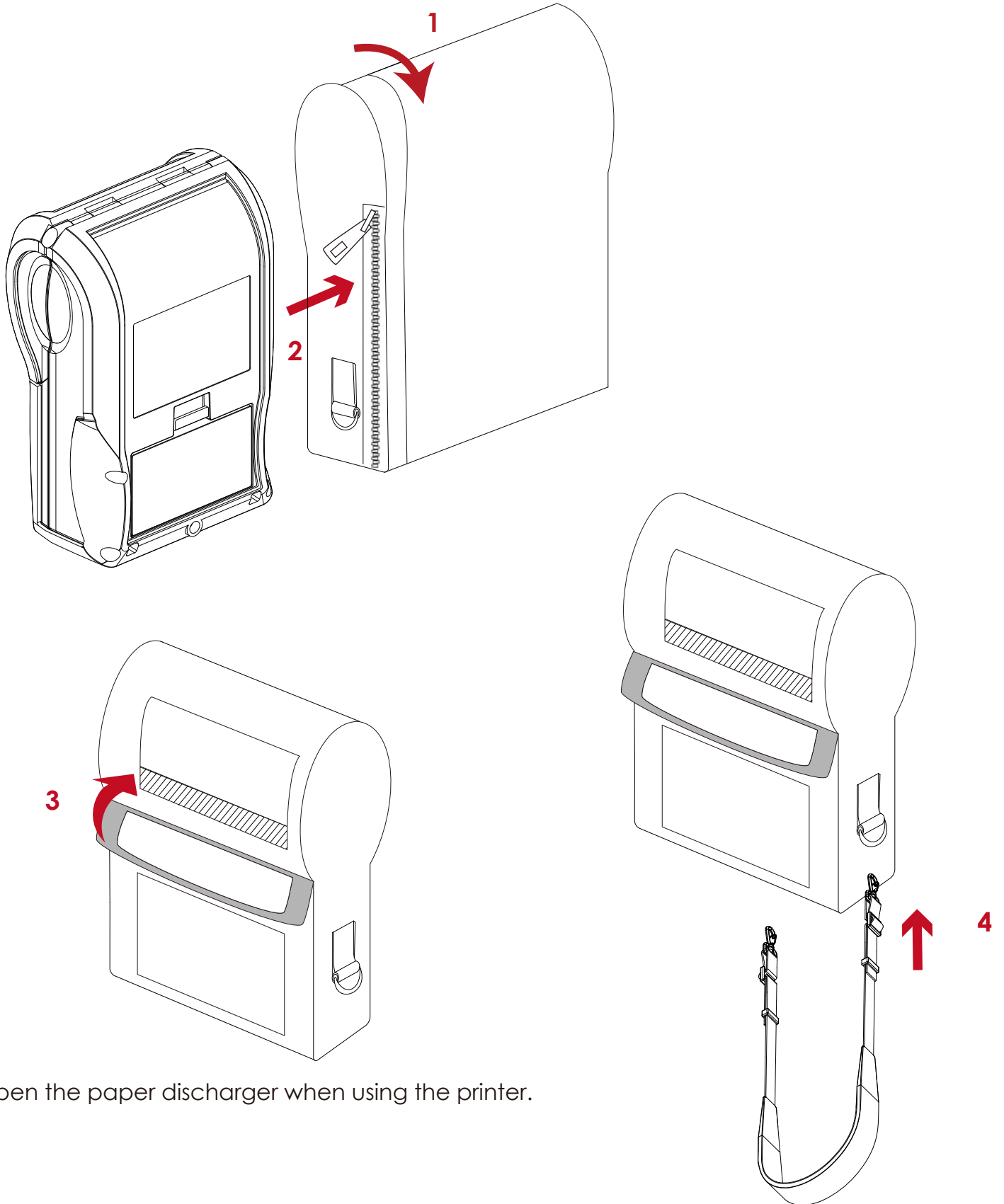

Open the paper discharger when using the printer.

Connect the clips of the leather case with the shoulder strap.

5 Maintenance and Adjustments

5.1 Cleaning the Thermal Print Head

Dirt on the print head, or glue residue from the label stock may result in inadequate print quality. The printer cover must therefore always be closed during printing. Keeping dirt and dust away from the paper or labels ensures a good print quality and a longer lifespan of the print head.

Cleaning Steps

Here is how to clean the print head.

1. Turn off the printer.
2. Open the printer cover.
3. To remove any label residue or other dirt from the print head, please use a soft lint-free cloth dipped with some alcohol.

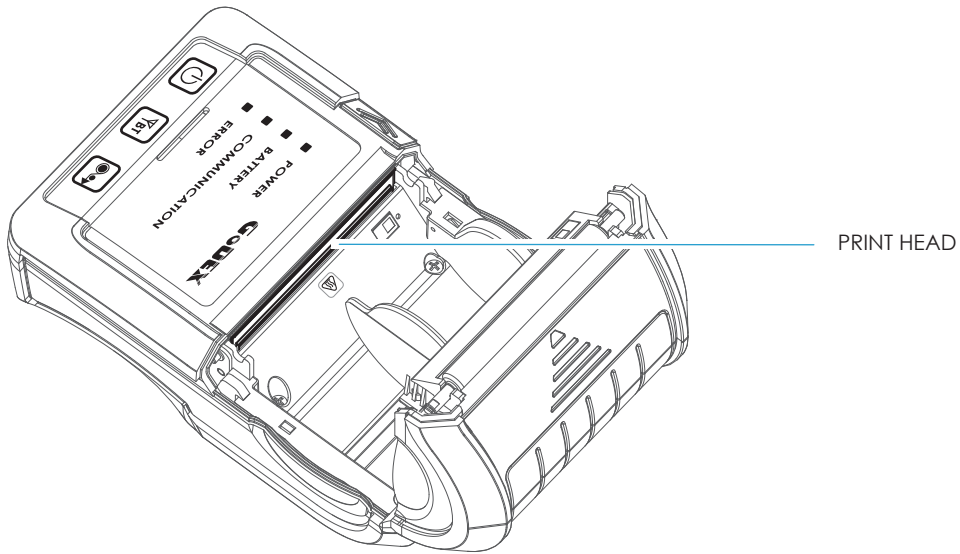

Note

-
- * Weekly to clean the print head one time. (Recommended)
 - ** When cleaning the print head, please note that if there is attached to metal or hard on soft cloth, if using a dirty soft cloth made printer head damage is not covered under warranty conditions.

5 Maintenance and Adjustment

5.2 Troubleshooting

Problem	Solution
The printer is switched on but the LED does not light up.	<ul style="list-style-type: none">◆ Check if the battery is full charged.
The LED lights up red and printing is interrupted.	<ul style="list-style-type: none">◆ Check the software settings (driver settings) or command codes.◆ Look for the error alert in the table in Section Error Alerts.◆ Check whether the print mechanism is closed correctly.
The paper roll passes through the printer but no image is printed.	<ul style="list-style-type: none">◆ Please make sure that the paper roll is loaded the right side up and that it is a suitable material.◆ Choose the correct printer driver.◆ Choose the correct paper roll and a suitable printing mode.
The label stock jams during printing.	<ul style="list-style-type: none">◆ Clear the paper jam. Remove any label material left on the thermal print head and clean the print head using a soft lint-free cloth dipped in alcohol. <p>Please see the Section 5.1</p>
There is no printed image on some parts of the label.	<ul style="list-style-type: none">◆ Check whether any label material is stuck to the thermal print head.◆ Check for errors in the application software.◆ Check whether the starting position has been set incorrectly.◆ Check the paper for wrinkles.◆ Check the power supply is correct
There is no printed image on part of the label or the image is blurred.	<ul style="list-style-type: none">◆ Check the thermal print head for dust or other dirt.◆ Use the internal "~T" command to check whether the thermal print head will carry out a complete print job.◆ Check the quality of the print medium.
The printed image is positioned incorrectly.	<ul style="list-style-type: none">◆ Check whether there is paper or dust covering the sensor.◆ Check whether the label stock is suitable. Contact your supplier.◆ Check the paper guide settings.
A label is missing during printing.	<ul style="list-style-type: none">◆ Check the label height setting.◆ Check whether there is dust covering the sensor.◆ Run the auto-detection function.
The printed image is blurred.	<ul style="list-style-type: none">◆ Check the darkness setting.◆ Check the thermal print head for dust or dirt. <p>Please see the Section 5.1</p>

Note

* If this does not resolve the problem, contact your dealer.

MX20/MX30/MX30i
USER MANUAL
APPENDIX
PRODUCT SPECIFICATIONS

Model		MX20
Print Method		Direct Thermal
Resolution		203 dpi (8 dots/mm)
Print Speed		Up to 4 IPS (101.6 mm/s)
Print Width		1.89" (48 mm)
Print Length		44.9" (~1142 mm)
Processor		32-bit RSIC CPU
Memory	Flash	128 MB Flash (40 MB for user storage)
	SDRAM	32 MB SDRAM
Sensor Type		Paper end sensor, Gap sensor
Media	Type	Direct Thermal receipt, anti-UV receipt, gap label, center alignment
		Inter-label gap size from 2 mm to 4 mm. 3 mm preferred
	Width	2.32" (59mm) fixed
	Media roll diameter	Max. 1.57" (40 mm)
	Thickness	Min 0.0508 mm, Max 0.165 mm
Printer Language		GPOS simulation or EZPL / GZPL / GEPL / GDPL simulations
Software	Label design software	GoLabel (for EZPL only)
	Driver	Vista, Windows 7, Windows 8 & 8.1, Windows 10, Windows Server 2008 R2, 2012, 2012 R2, 2016, 2019, MAC, Linux
	SDK	Win CE, .NET, Windows Vista, Windows 7, Windows 8 & 8.1, Windows 10, Android, Mac, iOS
Resident Fonts	Bitmap fonts	6, 8, 10, 12, 14, 18, 24, 30, 16x26 and OCR A & B. 0°, 90°, 180°, 270° rotatable
	TTF fonts	TTF (Bold / Italic / Underline). 0°, 90°, 180°, 270° rotatable
Download Fonts	TTF fonts	0°, 90°, 180°, 270° rotatable
	Asia fonts	16x16, 24 x 24. Traditional Chinese (BIG-5), Simplified Chinese(GB), Japanese (JIS), Korean (KS)
Barcodes	1-D Bar codes	China Postal Code, Codabar, Code 11, Code 32, Code 39, Code 93, Code 128 (subset A, B, C), EAN-8/EAN-13 (with 2 & 5 digits extension), EAN 128, FIM, German Post Code, GS1 DataBar, HIBC, Industrial 2 of 5, Interleaved 2-of-5 (I 2 of 5), Interleaved 2-of-5 with Shipping Bearer Bars, ISBT-128, ITF 14, Japanese Postnet, Logmars, MSI, Postnet, Plessey, Planet 11 & 13 digit, RPS 128, Standard 2 of 5, Telepen, Matrix 2 of 5, UPC-A/UPC-E (with 2 or 5 digit extension), UCC/EAN-128 K-Mart and Random Weight
	2-D Bar codes	Aztec code, Code 49, Codablock F, Datamatrix code, MaxiCode, Micro PDF417, Micro QR code, PDF417, QR code, TLC 39, GS1 Composite
Code Pages		CODEPAGE 437, 850, 851, 852, 855, 857, 860, 861, 862, 863, 865, 866, 869, 737 WINDOWS 1250, 1251, 1252, 1253, 1254, 1255, 1257 Unicode UTF8, UTF16
Graphics		Resident graphic file types are BMP and PCX, other graphic formats are downloadable from GoLabel
Interfaces		RS232+USB 2.0 port, mini-B type connector Bluetooth 2.1+EDR
Control Panel		4 dual color LEDs for Power, Battery, Communication, Error status indication. 3 buttons for Power, Feed and BT functions
Power Adapter		Switching power supply I/P: 100 / 240 V AC, 50 / 60 Hz, DC 9 V / 2.0 A
Battery		Rechargeable DC 7.4 V Lithium-ion battery, 1150 mAH or higher capacitance
Environment	Operation temperature	32°F to 122°F (0°C to 50°C)
	Storage temperature	-4°F to 140°F (-20°C to 60°C)
Humidity	Operation	10-90%, non-condensing
	Storage	10-90%, non-condensing
IP Rating		Intrusion Protection, IP42 requirement for case design, IP54 for protective case
Drop Level		1.5 meter height
Agency Approvals		CE EMC, FCC part 15B class B, FCC Part 15C, CCC, SRRC, NCC, CB, UL, cUL
Dimension	Length	5.1" (129.55 mm)
	Height	2.0" (51 mm)
	Width	3.3" (84 mm)
Weight		0.72 lbs (325g, with Battery, without protective case)
Options		Shoulder Strap, Li-ion battery, Battery charger station, Car charger adapter, RS-232 cable, Protective case

Notice

Specifications are subject to change without notice. All company and/or product names are trademarks and/or registered trademarks of their respective owners.

** Minimum print height and maximum print speed specification compliance can be dependent on non variables such as label type, thickness, spacing, liner construction, etc. Godex is pleased to test non minimum print height and maximum print speed capability.

MX20/MX30/MX30i
USER MANUAL
APPENDIX
PRODUCT SPECIFICATIONS

Model	MX30	MX30i
Print Method	Direct Thermal	
Resolution	203 dpi (8 dots/mm)	
Print Speed	up to 4 IPS (101.6 mm/s)	
Print Width	2.8" (72 mm)	
Print Length	30" (~762 mm)	
Processor	32-bit RSIC CPU	
Memory	Flash	128 MB Flash (40 MB for user storage)
	SDRAM	32 MB SDRAM
Sensor Type	Paper end sensor, Gap sensor	
Media	Type	Direct Thermal receipt, anti-UV receipt, gap label, left side alignment
	Inter-label gap size	Inter-label gap size from 2 mm to 4 mm. 3 mm preferred
	Width	Max. 3.15" (80 mm), Min. 1.5" (38.1 mm)
	Media roll diameter	Max. Media roll diameter : 2.35" (60mm)
	Thickness	Min 0.0508 mm, Max 0.165 mm
Printer Language	GPOS simulation or EZPL / GZPL / GEPL / GDPL simulations	
Software	Label design software	GoLabel (for EZPL only)
	Driver	Vista, Windows 7, Windows 8 & 8.1, Windows 10, Windows Server 2008 R2, 2012, 2012 R2, 2016, 2019, MAC, Linux
	SDK	Win CE, .NET, Windows Vista, Windows 7, Windows 8 & 8.1, Windows 10, Android, Mac, iOS
Resident Fonts	Bitmap fonts	6, 8, 10, 12, 14, 18, 24, 30, 16x26 and OCR A & B. 0°, 90°, 180°, 270° rotatable
	TTF fonts	TTF (Bold / Italic / Underline). 0°, 90°, 180°, 270° rotatable
Download Fonts	TTF fonts	0°, 90°, 180°, 270° rotatable
	Asia fonts	16x16, 24 x 24. Traditional Chinese (BIG-5), Simplified Chinese (GB), Japanese (JIS), Korean (KS)
Barcodes	1-D Bar codes	China Postal Code, Codabar, Code 11, Code 32, Code 39, Code 93, Code 128 (subset A, B, C), EAN-8/EAN-13 (with 2 & 5 digits extension), EAN 128, FIM, German Post Code, GS1 DataBar, HIBC, Industrial 2 of 5, Interleaved 2-of-5 (I 2 of 5), Interleaved 2-of-5 with Shipping Bearer Bars, ISBT-128, ITF 14, Japanese Postnet, Logmars, MSI, Postnet, Plessey, Planet 11 & 13 digit, RPS 128, Standard 2 of 5, Telepen, Matrix 2 of 5, UPC-A/UPC-E (with 2 or 5 digit extension), UCC/EAN-128 K-Mart and Random Weight
	2-D Bar codes	Aztec code, Code 49, Codablock F, Datamatrix code, MaxiCode, Micro PDF417, Micro QR code, PDF417, QR code, TLC 39, GS1 Composite
Code Pages	CODEPAGE 437, 850, 851, 852, 855, 857, 860, 861, 862, 863, 865, 866, 869, 737 WINDOWS 1250, 1251, 1252, 1253, 1254, 1255, 1257 Unicode UTF8, UTF16	
Graphics	Resident graphic file types are BMP and PCX, other graphic formats are downloadable from GoLabel	
Interfaces	RS232+USB 2.0 port, mini-B type connector Bluetooth 2.1+EDR	
Control Panel	4 dual color LEDs for Power, Battery, Communication, Error status indication. 3 buttons for Power, Feed and BT functions	
LCD Display	N/A	Graphic OLED 128 x 64 dots with 3 buttons for Up, Down and Enter functions
RTC	N/A	Standard
Power Adapter	Switching power supply I/P: 100 / 240 V AC, 50 / 60 Hz, DC 9 V / 2.0 A	
Battery	Rechargeable DC 7.4 V Li-ion battery, 2500 mAh or higher capacitance	
Environment	Operation temperature	32°F to 122°F (0°C to 50°C)
	Storage temperature	-4°F to 140°F (-20°C to 60°C)
Humidity	Operation	10-90%, non-condensing
	Storage	10-90%, non-condensing
IP Rating	Intrusion Protection, IP42 requirement for case design, IP54 for protective case	
Drop Level	1.5 meter height	
Agency Approvals	CE EMC, FCC part 15B class B, FCC Part 15C, CCC, SRRC, NCC, CB, UL, Energy Star V2.0	
Dimension	Length	6.71" (170.63 mm)
	Height	3.11" (79 mm)
	Width	4.48" (114.01 mm)
Weight	1.45lbs (660g, with battery, without protective case)	1.47lbs (670g, with battery, without protective case)
Options	WiFi (IEEE 802.11b/g/n)	
	RS-232 cable	
	Li-ion battery	
	Protective case	
	Battery charger station · Car charger adapter	

Notice

Specifications are subject to change without notice. All company and/or product names are trademarks and/or registered trademarks of their respective owners.

** Minimum print height and maximum print speed specification compliance can be dependent on non variables such as label type, thickness, spacing, liner construction, etc. Godex is pleased to test non minimum print height and maximum print speed capability.

MX20/MX30/MX30i
USER MANUAL
APPENDIX
INTERFACE

Pinout Description

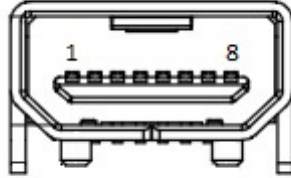

- USB Port (mini-B Type)

Pin No.	1	2	3	4	5	6	7	8
Function	GND	VBUS	D-	D+	TXD	CTS	RXD	RTS

MX20/MX30/MX30i
USER MANUAL
Appendix
MX 30/30i WiFi Setting

1.1 Check the Wireless Access Point Setting Value

Connect MX30/30i Wireless Module to Wireless Access Point, and then connect the Module to the Mobile phones or computers through network.

About the parameters of wireless access point, please refer to the figure below (Example : D-Link AP)

The screenshot shows a web-based configuration page for wireless network settings. It is divided into several sections: NETWORK SETTINGS, WIRELESS NETWORK SETTINGS, WIRELESS SECURITY MODE, WPA, and PRE-SHARED KEY. Red boxes and arrows highlight specific fields: 'Wireless Network Name' (labeled SSID), 'WPA Mode' (labeled Security), and 'Pre-Shared Key' (labeled PRE-SHARED KEY). The interface includes various dropdown menus, radio buttons, and text input fields.

changes made on this section may also need to be duplicated on your Wireless Client.

Save Settings Don't Save Settings

WIRELESS NETWORK SETTINGS

Enable Wireless : Always Add New

Wireless Network Name : [MXAP] (Also called the SSID) ← SSID

802.11 Band : 2.4GHz 5GHz

802.11 Mode : [Mixed 802.11n, 802.11g and 802.11b]

Enable Auto Channel Scan :

Wireless Channel : [2.437 GHz - CH 6]

Transmission Rate : [Best (automatic)] (Mbit/s)

Channel Width : [20 MHz]

Visibility Status : Visible Invisible

WIRELESS SECURITY MODE

To protect your privacy you can configure wireless security features. This device supports three wireless security modes, including WEP, WPA-Personal, and WPA-Enterprise. WEP is the original wireless encryption standard. WPA provides a higher level of security. WPA-Personal does not require an authentication server. The WPA-Enterprise option requires an external RADIUS server.

Security Mode : [WPA-Personal]

WPA

Use WPA or WPA2 mode to achieve a balance of strong security and best compatibility. This mode uses WPA for legacy clients while maintaining higher security with stations that are WPA2 capable. Also the strongest cipher that the client supports will be used. For best security, use WPA2 Only mode. This mode uses AES(CCMP) cipher and legacy stations are not allowed access with WPA security. For maximum compatibility, use WPA Only. This mode uses TKIP cipher. Some gaming and legacy devices work only in this mode.

To achieve better wireless performance use WPA2 Only security mode (or in other words AES cipher).

WPA Mode : [Auto (WPA or WPA2)] ← Security

Cipher Type : [AES]

Group Key Update Interval : [] (seconds)

PRE-SHARED KEY

Enter an 8- to 63-character alphanumeric pass-phrase. For good security it should be of ample length and should not be a commonly known phrase.

Pre-Shared Key : [] ← PRE-SHARED KEY

MX20/MX30/MX30i
USER MANUAL
Appendix
MX 30/30i WiFi Setting

1.2 Set up MX 30/30i Wireless Network through Godex WiFi tool

- Step 1. Connect MX 30/30i and computer by USB cable
- Step 2. Turn on MX 30/30i
- Step 3. Start Golabel
- Step 4. Select printer model to MX30/30i (see the screenshot below)

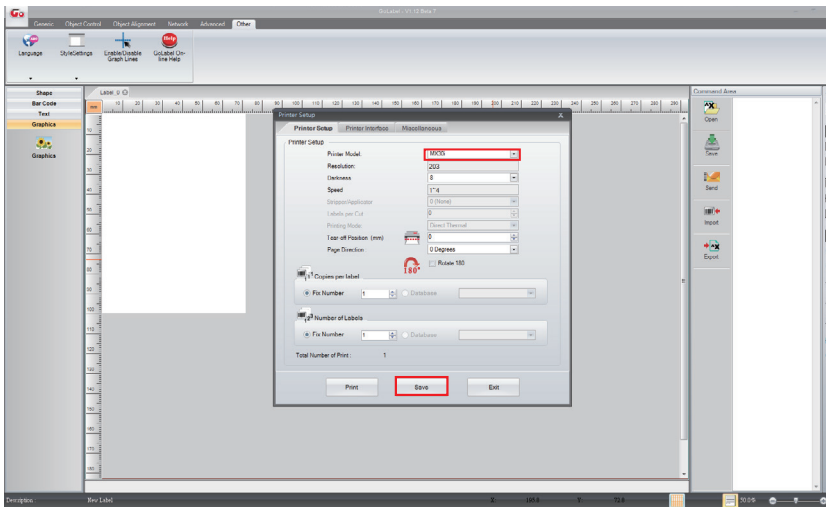

Step 5. Click "WiFi Setting" icon (see the screenshot below)

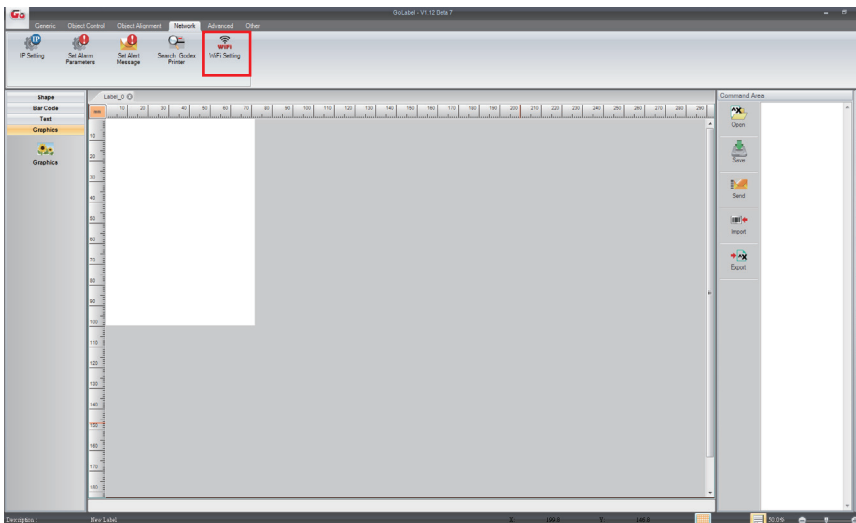

MX20/MX30/MX30i
USER MANUAL
Appendix
MX 30/30i WiFi Setting

Step 6. Input parameters of wireless access point (see the screenshot below)

Step 7. Click "Set Data" icon, and the printer will reboot

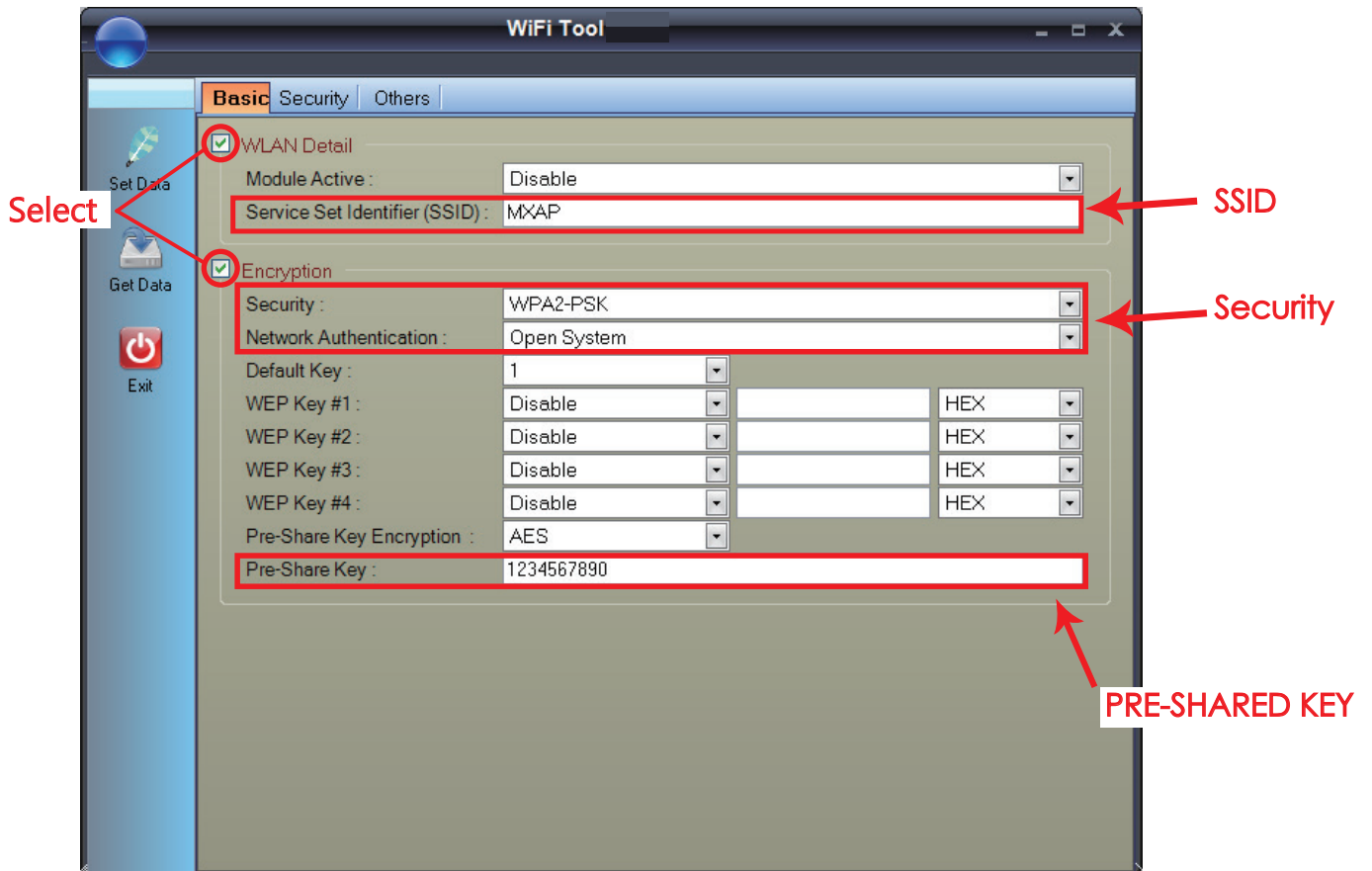

PS : If printer doesn't reboot after a few seconds and 3 beeps are not heard, please repeat the steps from chapter 1.2)

MX20/MX30/MX30i
USER MANUAL
Appendix
MX 30/30i WiFi Setting

1.3 Activate DHCP function for MX30/30i

1. First of all, configure DHCP function through USB

Steps : Click "Generic" ➡ Click "Printer Setup" ➡ Select "USB port/GoDEX MX30/30i"
➡ Click "Save"

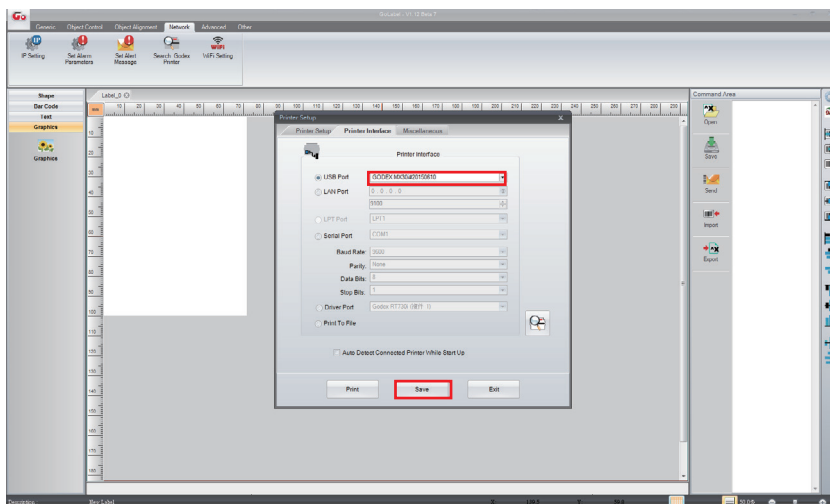

2. Obtain the printer IP address through WiFi Setting
(Please refer to the screenshot below)

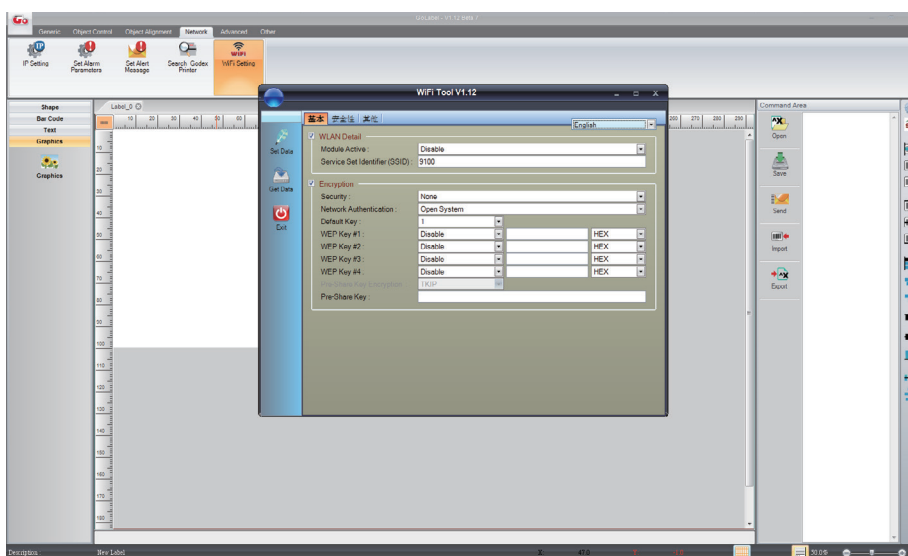

APPENDIX

MX30/30i WiFi Madule Installation

Step 1.

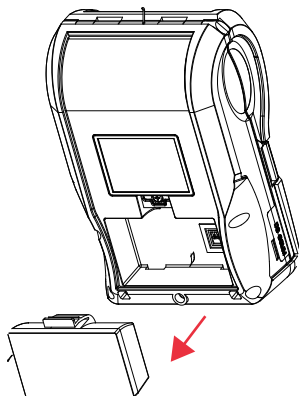

關閉電源,取下電池
Turn off the power
and remove the battery

Step 2.

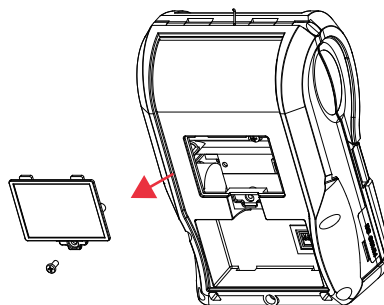

取下底座遮蓋
Remove the bottom cover

將 WiFi 電子板鎖在遮蓋上
Lock the WiFi electronic board
on the cover

Step 3.

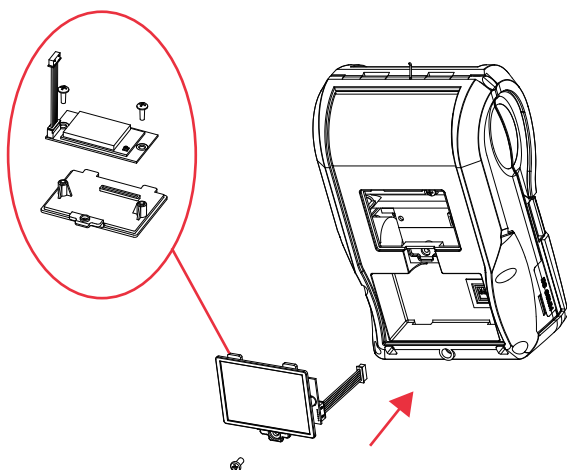

將模組接頭插上主板,鎖上 WiFi 模組
Plug the connector on main board
and locked WiFi module

Step 4.

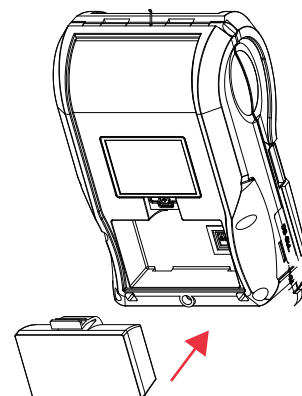

裝回電池
Install the battery

APPENDIX

Wi-Fi Printer Server Module Installation(Quick Setting)



* Quick setting only supports GoLabel 1.15K and Arm 7 (FW1.100)
Or Arm 9 (FW2.00A) or higher version

Set up wireless network through GoDEX WiFi tool

1. Turn on the printer,connect printer and computer by USB cable.
2. Start GoLabel.
3. "Generic" →" **Printer Setup**" .

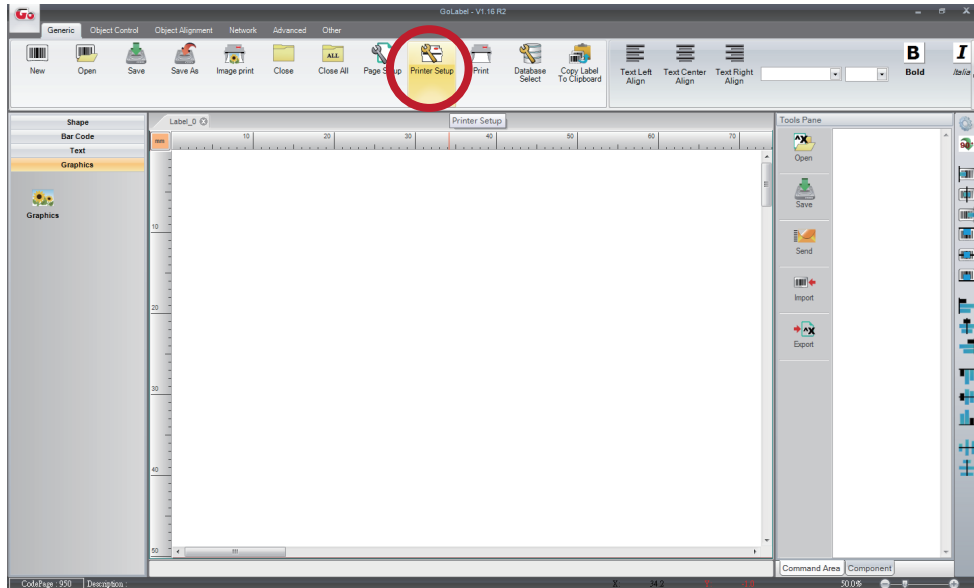

4. Select printer model(Wi-Fi supported models).

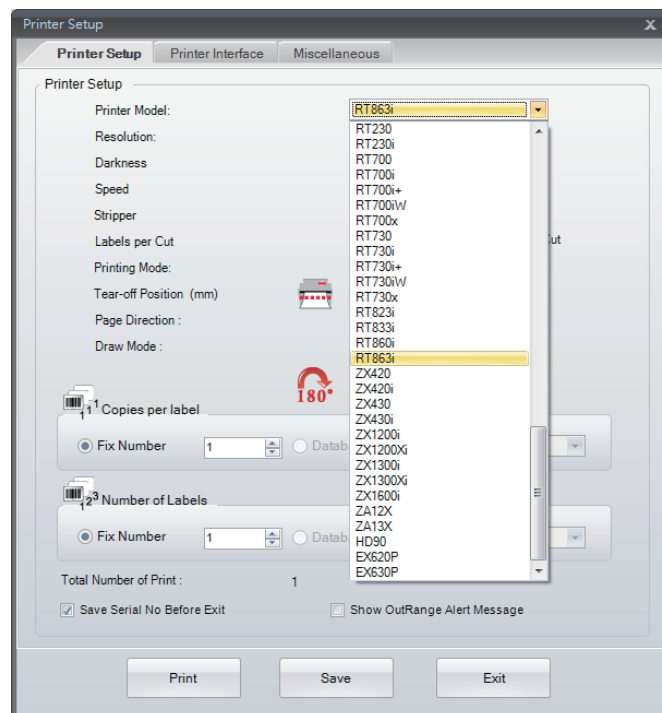

APPENDIX

Wi-Fi Printer Sever Module Installation(Quick Setting)



5. Click " WiFi Setting " icon.

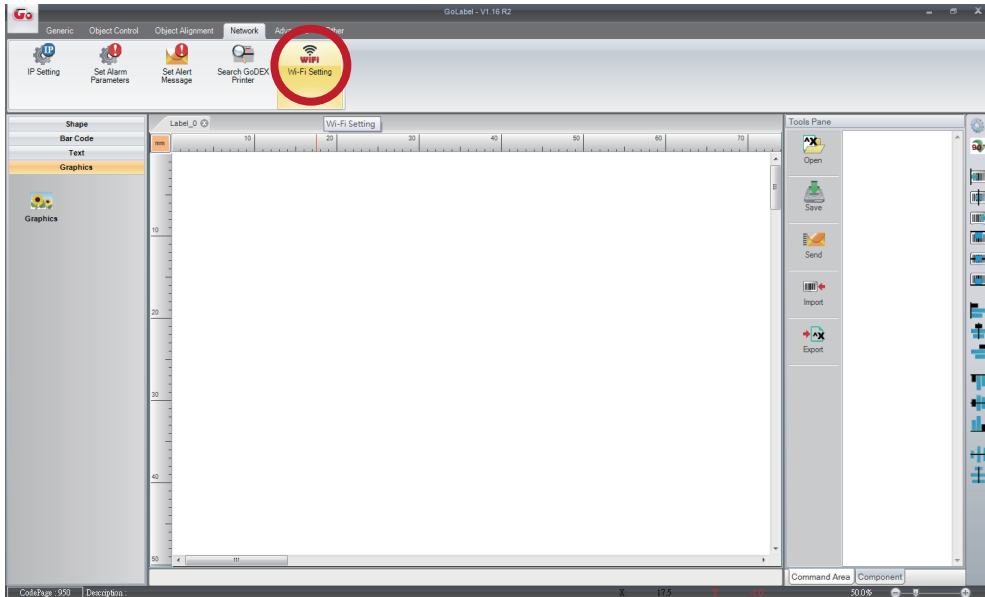

6. Click " Quick Setting " icon.

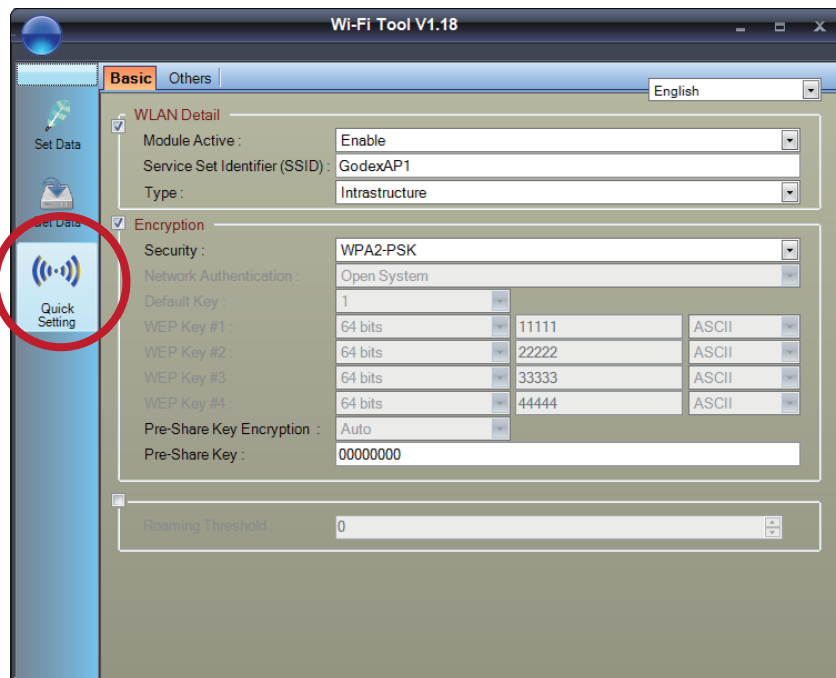

APPENDIX

Wi-Fi Printer Sever Module Installation(Quick Setting)



8. Select server and click **next** button.

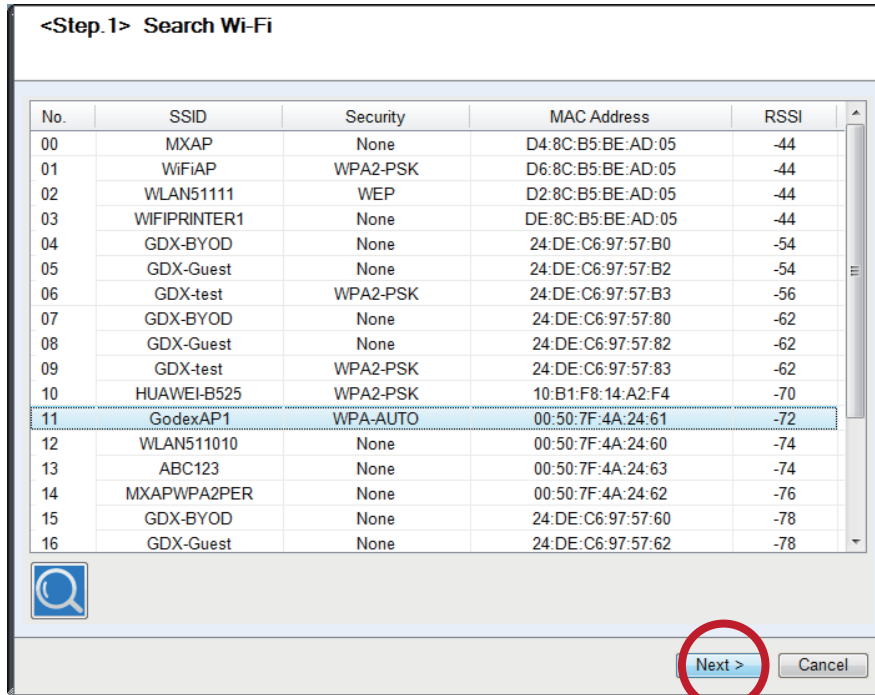

9. Enter the **password** set on the server side and click the **"Setting"** button.

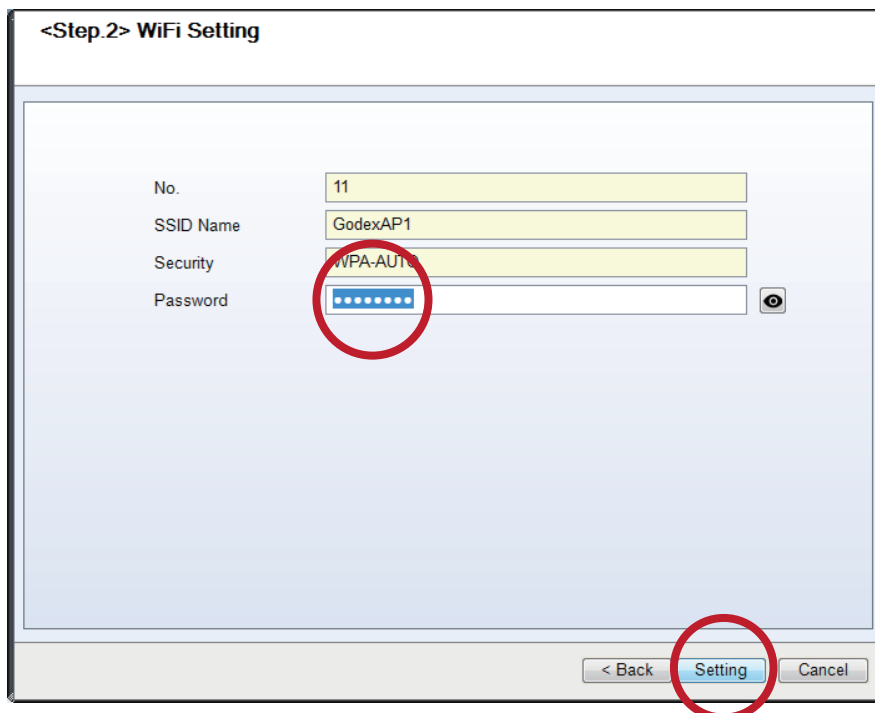

APPENDIX



Wi-Fi Printer Sever Module Installation(Quick Setting)

10. After the setting succeeded, a prompt will pop up and the printer will restart.

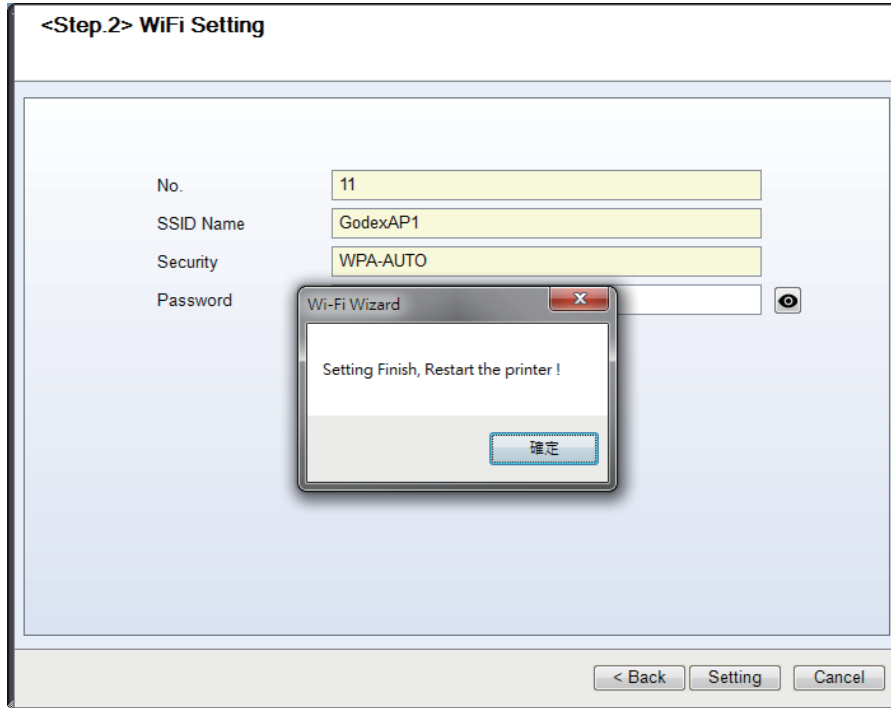

11. Select the "Other" tab and click the "Get Data" icon after selecting "IP Settings".

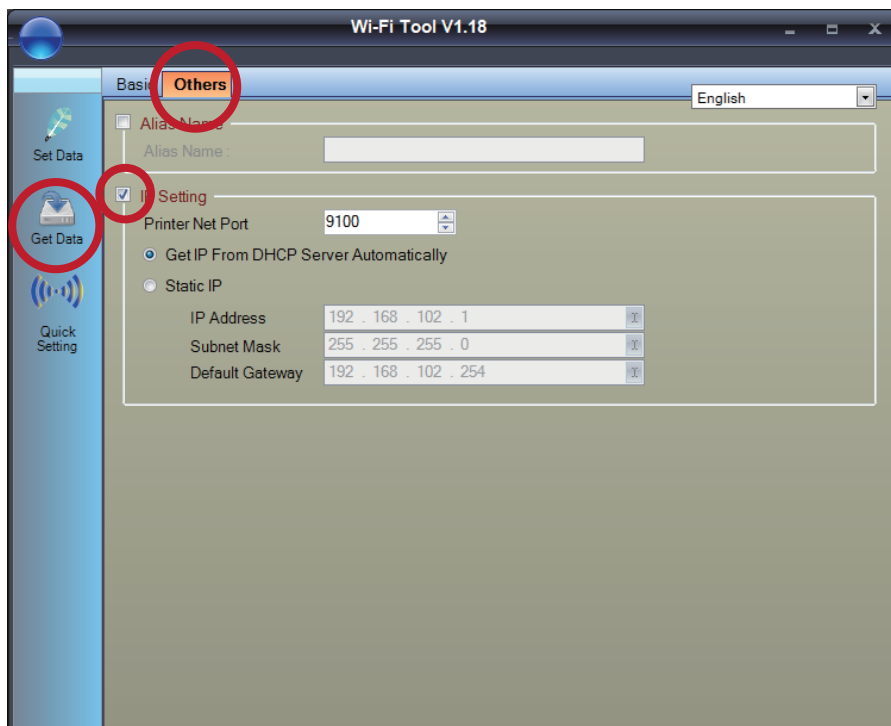

APPENDIX



Wi-Fi Printer Sever Module Installation(Quick Setting)

12. After remembering the IP address, open the "Printer Settings" window.

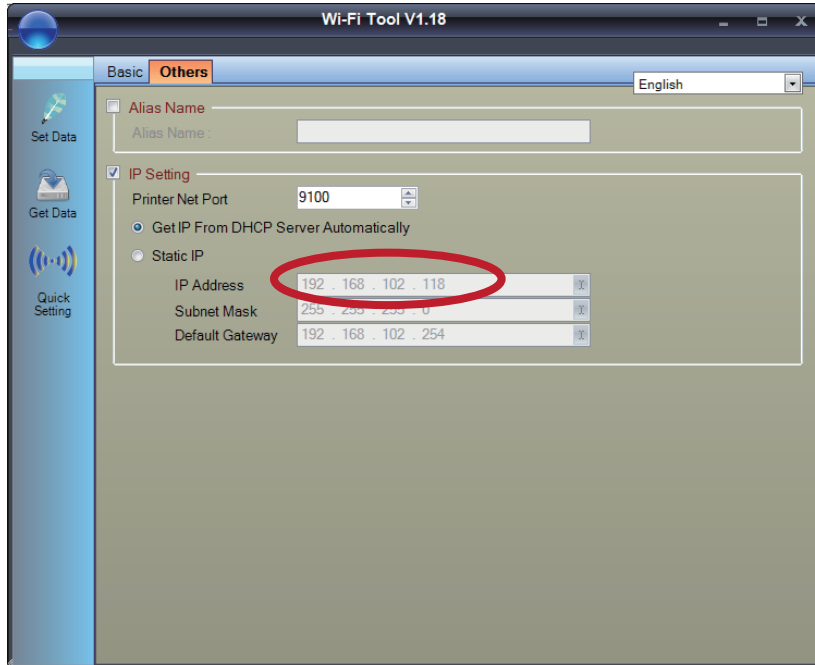

13. Select the "Printer Interface" tab, fill in the IP address and click "Save" to complete the setting.

